

- 5.8GHz FPV real time Image monitor
- 5" LCD screen
- Telemetry function



User Handbook

Specifications:

Encoder: 12-channel micro computer system

Frequency: 2.4GHz DSSS

Output power: ≤100 mW

Output pulse: 1000—2000Us (1500Us Neutral)

Power supply: LiPo 7.4V/11.1V 1600-3000mAh or 5# Battery 8x1.5V or NiMH 8x1.2V 1600-3000mAh

Current drain: Close the video ≤300 mA (100 mW); View the video ≤430 mA (100 mW)

Features:



12 channel multifunctional settings



5" LCD screen



5.8G real time image transmission



Telemetry function



Wireless data transmission



RF transmitter powers adjustable



Helicopter/Airplane/Glider



Multi languages optional



4 stick modes switchable



Up to 15-model data can be saved



Auto code banding and fixed code free settable



USB online firmware update

Contents

Part one: General information

1.0 General information	4
1.1 Important statements	4
1.2 Safety needing attention	4
1.3 Attention before flight	4
2.0 Features	7
2.1 Transmitter DEVO F12E	7
2.2 Features of DEVO-RX1202	7
3.0 Specification	7
3.1 DEVO-F12E transmitter specification	7
3.2 Receiver specification	7
4.0 Definition of DEVO F12E	8
4.1 Panel definition	8
4.2 Rear definition	8
4.3 Wiring Diagram	9
4.4 Function keys in panel	9
5.0 Control Stick Adjustment	9
5.1 The stick length adjustment	9
5.2 Control Stick Tension Adjustment	10
6.0 Neck Strap Usage	10
7.0 Stick Mode Switch	10
8.0 Switches between left-hand and right-hand throttles	11
8.1 Right-hand throttle switched to left-hand throttle	11
8.2 Left-hand throttle switched to right-hand throttle	12
9.0 Training function	13
10.0 Customized fixed ID	14
11.0 Installation requirement for receiver	15
11.1 Receiver Frame rate setting	15
12.0 Installation requirement for DEVO F12E battery pack	16
12.1 DEVO F12E Battery Charging	16

Part two: Helicopter

1.0 System Menu	18
1.1 Language setting	18
1.2 Display	18
1.3 Buzzer warning	19
1.4 Vibrator	19
1.5 Video Setting	19
1.6 Stick Mode	20
1.7 Stick Direction	20
1.8 Stick Calibration	20
1.9 Battery	21
1.10 About	21
2.0 Model Menu	21
2.1 Model Select	21
2.2 Model Name	22
2.3 Model Copy	22
2.4 Model wireless copy	22
2.5 Model reset	23
2.6 Type Select	24
2.7 Trim System	24
2.8 Stick Position Switch	24
2.9 Device select	25
2.10 Device Output	26
2.11 Swash Type	27
2.12 Power Amplifier	27
2.13 Fixed ID	27
2.14 Sensor setting	28
3.0 Function Menu	30
3.1 Reverse Switch	30
3.2 Travel Adjust	30
3.3 Sub Trim	31
3.4 Dual rate and Exponential	31
3.5 Throttle Hold	32
3.6 Throttle Curve	33
3.7 Mix to throttle	34

3.8 Gyro Sensor	36
3.9 Governor	36
3.10 Tail Curve	37
3.11 Dual Pitch	38
3.12 Swash Mix	38
3.13 Pitch Curve	39
3.14 Program Mix	41
3.15 Monitor	43
3.16 Fail safe	44
3.17 Sensor View	44
3.18 Trainer	45
3.19 Timer	47

Part three: Airplane

1.0 System Menu	49
1.1 Language setting	49
1.2 Display	49
1.3 Buzzer warning	50
1.4 Vibrator	50
1.5 Video Setting	50
1.6 Stick Mode	51
1.7 Stick Direction	51
1.8 Stick Calibration	51
1.9 Battery	52
1.10 About	52
2.0 Model Menu	52
2.1 Model Select	52
2.2 Model Name	53
2.3 Model Copy	53
2.4 Model wireless copy	53
2.5 Model reset	54
2.6 Type Select	55
2.7 Trim System	55
2.8 Stick Position Switch	55
2.9 Device select	56
2.10 Device Output	57

2.11 Wing Type	58
2.12 Power Amplifier	60
2.13 Fixed ID	60
2.14 Sensor setting	61

3.0 Function Menu	63
3.1 Reverse Switch	63
3.2 Travel Adjust	64
3.3 Sub Trim	64
3.4 Dual rate and Exponential	64
3.5 Throttle Hold	65
3.6 Throttle Curve	66
3.7 Differential	68
3.8 Balance	69
3.9 Gyro sensor	70
3.10 Governor	71
3.11 Aileron to Rudder Mix	72
3.12 Elevator to flap mix	72
3.13 Rudder to aileron/elevator mix	73
3.14 Flap System	74
3.15 Aileron to flap mix	75
3.16 Pitch Curve	76
3.17 Program mix	77
3.18 Monitor	80
3.19 Fail safe	80
3.20 Sensor View	81
3.21 Trainer	82
3.22 Timer	83

Part four: Glider

1.0 System Menu	85
1.1 Language setting	85
1.2 Display	85
1.3 Buzzer warning	86
1.4 Vibrator	86
1.5 Video Setting	86

1.6 Stick Mode -----	87	3.14 Aileron to flap mix -----	106
1.7 Stick Direction -----	87	3.15 Aileron to Tip-Aileron Mix -----	106
1.8 Stick Calibration-----	87	3.16 Flap Rate -----	107
1.9 Battery -----	88	3.17 Brake System -----	107
1.10 About -----	88	3.18 Program mix -----	108
2.0 Model Menu -----	88	3.19 Monitor -----	111
2.1 Model Select -----	88	3.20 Fail safe -----	111
2.2 Model Name-----	89	3.21 Sensor View -----	112
2.3 Model Copy-----	89	3.22 Trainer -----	113
2.4 Model wireless copy-----	89	3.23 Timer -----	114
2.5 Model reset-----	90		
2.6 Type Select -----	91	4.0 Upgrading -----	114
2.7 Trim System -----	91		
2.8 Stick Position Switch-----	91		
2.9 Device select -----	92		
2.10 Device Output -----	93		
2.11 Wing Type -----	94		
2.12 Power Amplifier-----	94		
2.13 Fixed ID -----	95		
2.14 Sensor setting -----	96		
3.0 Function Menu -----	98		
3.1 Reverse Switch -----	98		
3.2 Travel Adjust -----	98		
3.3 Sub Trim -----	98		
3.4 Dual rate and Exponential -----	99		
3.5 Motor Hold -----	100		
3.6 Flaperon Mix-----	100		
3.7 Camber System -----	101		
3.8 Differential-----	102		
3.9 Balance -----	103		
3.10 Gyro sensor-----	103		
3.11 Rudder to Spoiler Mix-----	104		
3.12 Aileron to Rudder Mix-----	104		
3.13 Elevator to flap mix-----	105		

deVention

DEVO F12E

Part one General information

DEVO F12E takes 2.4 GHz Direct Sequence Spread Spectrum(DSSS) technology and features automatic ID binding, automatic ID assignment, and also features fixed ID by yourself. The usage of wireless copy function keeps you away from the trouble in wire link-up. Three model types of Helicopter, Airplane, and Glider are available to meet your requirements for different models. 5"LCD display, 5.8G real time image monitor, it offers you convenient operation, FPV makes the flight easier. Online update via USB ensures a transmitter in hand out not to be out of date and makes it full of vigour.

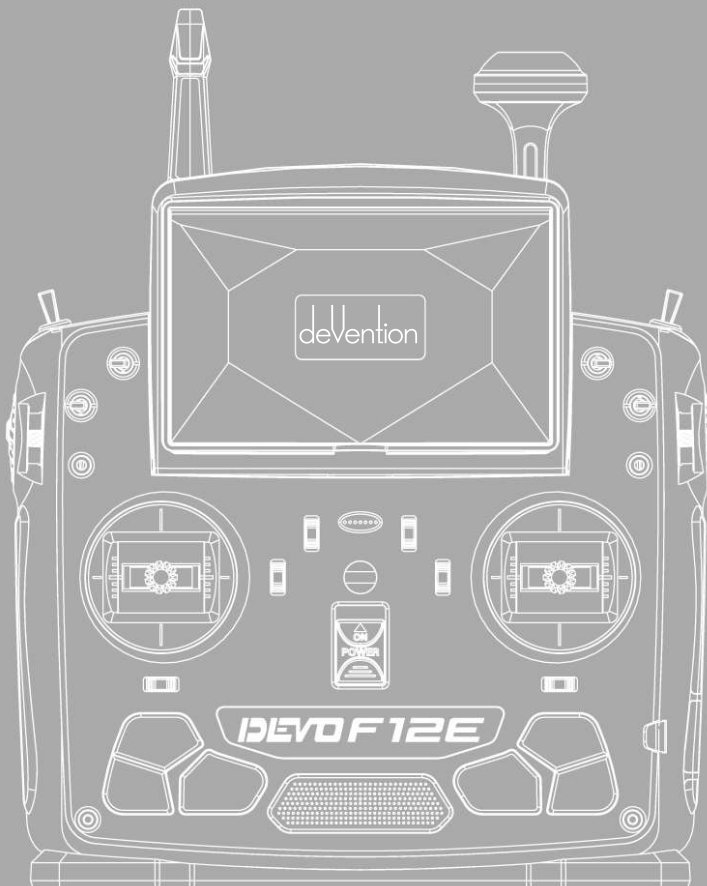

1.0 General information

1.1 Important statements

- (1) The transmitter is suitable for experienced pilots beyond 14 years old.
- (2) Flying the model aircraft in approved ground is a must.
- (3) We are not responsible for any safety caused by operation, usage or control once the transmitter is sold out.
- (4) We consign our distributors to offer technical support and service after sale. Please contact the local distributors for problem solutions caused by usage, operation, maintenance, etc.

1.2 Safety needing attention

- (1) Far away from obstacle and people.

RC aircraft in flights is uncertain of flight speed and status, which potential risk exists in when flying. Please keep your radio controlled aircraft far away from people, high buildings, high-tension line, etc, and avoid operating in rain, storms, thunder and lightening.



- (2) Away from humidity environment

Radio controlled aircraft should be kept away from humidity and vapor because it is composed of complicated precise electronic elements and mechanical parts.



- (3) Proper operation

Use original spare parts to upgrade, modify or maintain your equipment in order to assure its safety. Please operate your equipment within the range of functions permitted. It is forbidden to use out of the safety laws or regulations.



- (4) Safety operation

Operate your equipment according to your body status and flight skills. Fatigue, listlessness and mis-operation will increase the possibilities of accidental hazard.



- (5) Away from heat sources

The inside of the transmitter is composed of precise electronic components and mechanical parts. Keep it far away from heat sources and sunshine to avoid distortion, or even damage caused by high temperature.



1.3 Attention before flight

- (1) Ensure the battery packs of both transmitter and receiver are fully saturated.
- (2) Ensure both the throttle stick and the throttle trim of your DEVO F12E stay at the lowest positions before operation.

- (3) Strictly obey the order of TURN-ON and TURN-OFF before operation. When starting your flight, turn on your DEVO F12E first, and connect the battery to the aircraft last. When turning off the aircraft, disconnect the battery first, and turn off your DEVO F12E last. An upset in the order may cause your aircraft out of control. Cultivate a correct habit of turn-on and turn-off.
- (4) Ensure whether the directions and actions of all the servos in your RC aircraft are correct when executing commands of the transmitter. Using broken servos will result in unforeseen dangers.

2.0 Features

2.1 Transmitter DEVO F12E

- (1) The DEVO F12E adopts 2.4 GHz Direct Sequence Spread Spectrum (DSSS) technology and features automatic ID binding and ID assignment. It can also be customizedly set as fixed ID code.
- (2) USB online update makes you always enjoy the latest program.
- (3) Hi-frequency output power is adjustable.
- (4) Wireless data transmission between two DEVO F12E helps experience the training function.
- (5) Up to 15-model data can be saved.
- (6) DEVO F12E adjusting the gyro sensitivity makes hovering flight and fancy flight in an easy way.
- (7) Shape design accords with human engineering and provides comfortable holding.
- (8) Both the length and tension of the sticks can be amendable.
- (9) DEVO F12E can be freely switched among Modes 1, 2, 3, and 4.
- (10) DEVO F12E is suitable for Helicopter , Airplane and Glider. In the helicopter mode, there are three flight modes, each of which can be freely set and its parameters can be personalizedly adjusted to meet the requirement for F3C or 3D aerobatic flight.

2.2 Features of DEVO-RX1202

- (1) Adopts 2.4GHz Direct Sequence Spread Spectrum (DSSS) that features fast reaction and strong anti-jamming protection.
- (2) Double receiving circuits and signal switch automatically effectively assure the stability of receiving signal.
- (3) The single chip Micro as CPU provides super-strong analyzing ability.
- (4) The receiver maintains the frequency and the ID memories when its changing a new battery pack with the transmitter powered on .
- (5) It can be customizedly set as fixed ID and automatic ID assignment.

3.0 Specification

3.1 DEVO F12E transmitter Specification

- Encoder 12-channel micro computer system
- Frequency 2.4GHz DSSS
- Output power..... ≤ 100 mW
- Current drain Close the video ≤ 300 mA (100mW); View the video ≤ 430 mA (100mW)
- Power supply..... LiPo 7.4v/11.1v 1,600 - 3,000mAh or 5# Battery 8 X1.5V or NiMH 8 X1.2V 1,600 - 3,000mAh
- Output pulse 1000 – 2000US (1500US Neutral)

3.2 Receiver specification

- Type 2.4GHz 12 channels
- Sensitivity..... - 105 dbm
- Frequency interval ≥ 4 M
- Weight 15 g
- Dimension 47X32X16mm
- Receiver Battery 4.8-6V 1,300mAh

4.0 Definition of DEVO F12E

4.1 Panel definition



4.2 Rear definition



- (1) Digital Signal Converter socket (DSC): used for simulator flight practice via computer (You need software and its dongle which are available in hobby shops), and for training.
- (2) USB socket: The USB socket combined with PC machine can upgrade the device program, upload and download the Configuration parameters.

4.3 Wiring Diagram

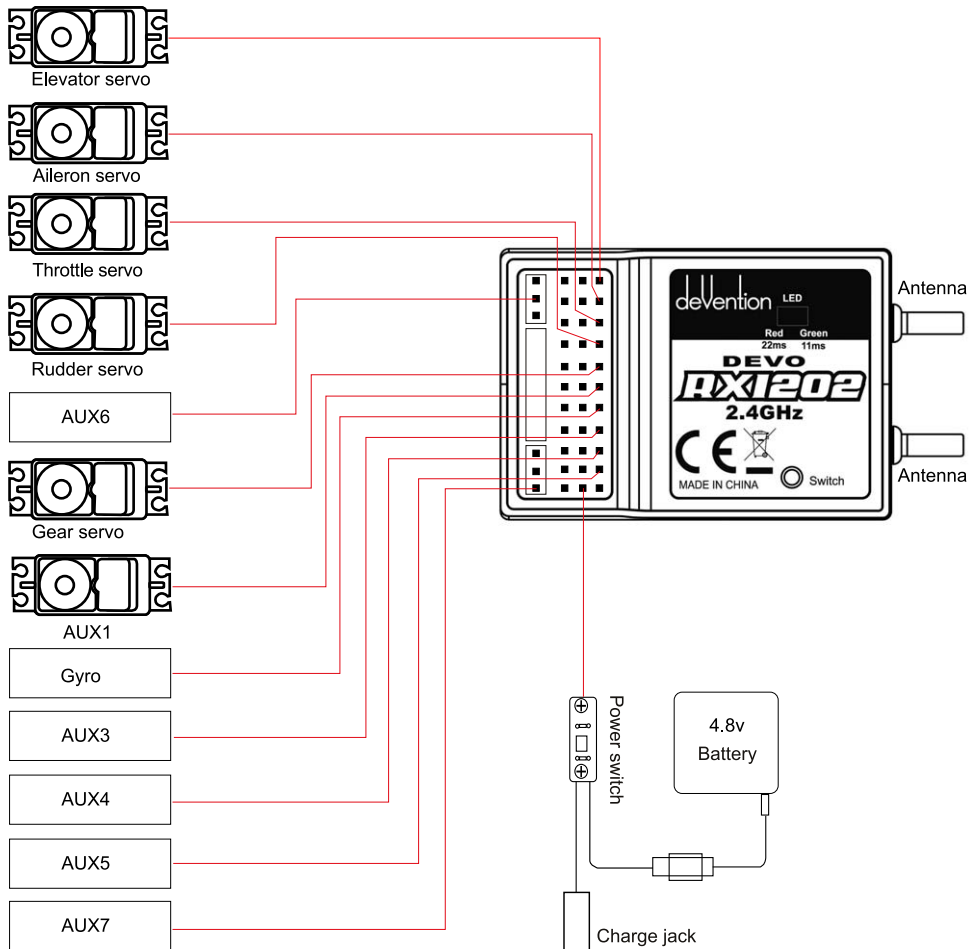

4.4 Function keys in panel

There are 6 functional keys in the panel of DEVO F12E. Below are the details:

- (1) EXT: Reset key. Press EXT to exit the main menu.
- (2) ENT: Confirmation key. Press ENT to access the system or the function mode.
- (3) UP: Moves cursor up to the forward function item.
- (4) DN: Moves cursor down to the next function item.
- (5) R: Moves cursor right to increase the setting value.
- (6) L: Moves cursor left to decrease the setting value.

5.0 Control Stick Adjustment

Stick adjustment control has two parts: the stick length and degree of tightness.

5.1 The stick length adjustment

- (1) Prolong the stick length: Counter clockwise rotate the stick head until the length you hope, and then counter clockwise tighten the stick sleeve.
- (2) Shorten the stick length: Clockwise rotate the stick sleeve until the length you hope, and then clockwise tighten the stick head.



5.2 Control Stick Tension Adjustment

Use a cross screwdriver to adjust the rear cover screw show as below. Clockwise will increase stick tension and counter-clockwise reduce it.



6.0 Neck Strap Usage

The neck strap can be hooked on the face of the transmitter. The Hook located at the center helps to get optimal balance of the transmitter.

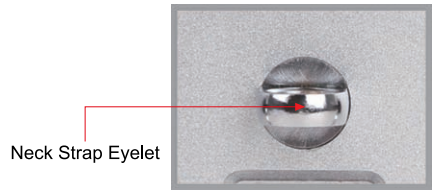

7.0 Stick Mode Switch

There are total four stick modes from MODE 1 through MODE 4. The left-hand throttle includes MODE 2 and MODE 4, and the right-hand throttle includes MODE 1 and MODE 3. Below is the sketch map:

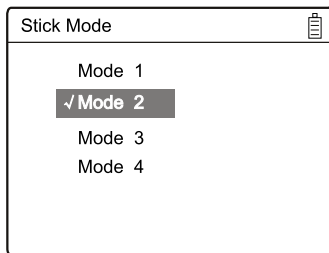

MODE 2 and MODE 4 are listed in left-hand throttle.

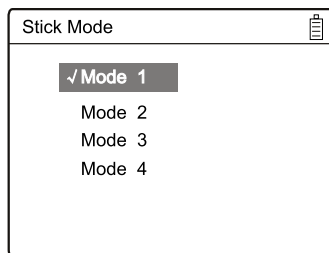
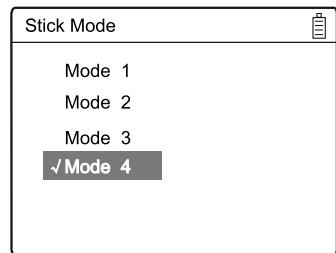

MODE 1 and MODE3 are listed in right-hand throttle.

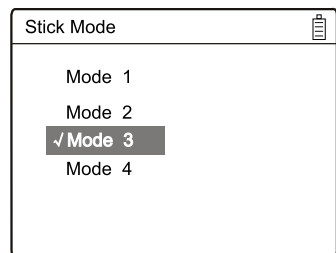

8.0 Switches between left-hand and right-hand throttles

The throttle switch between the left hand and right hand will be successful if both the MECHANICAL switch and ELECTRONIC switch are finished, separately. Below are the methods for switching:

8.1 Right-hand throttle switched to left-hand throttle

(1) Mechanical switch

1 Open battery cover at the bottom of radio and take out battery .



2 Use a driver to take out screws from A1 to A4, remove the floor board .



3 Use a driver to take out screws from B1 to B4, then remove the left lateral, right lateral non-slipping blocks, respectively, as below photo.



Below are shown the inside views of left and right throttle sets, respectively. Use cross screwdriver to loosen and remove Linkage Fixed Screw, Screw F, Screw G, and Throttle Control Spring in right throttle set, respectively, and then mount them in the corresponding positions in left throttle set. And then adjust the stick tension if you like.

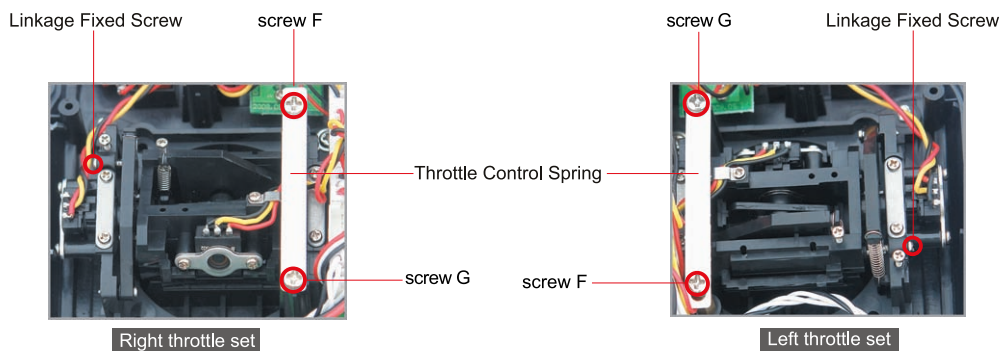

(2) The ELECTRONIC switch

In the main interface, press ENT to access the main menu; Press UP\DN to choose “system menu”; Press UP\DN to choose “stick model” and access via “ENT” key, or to choose “model 2\4” and confirm via ENT key, make a mark “✓” before the choosed model. Press EXT to exit after setup complete.

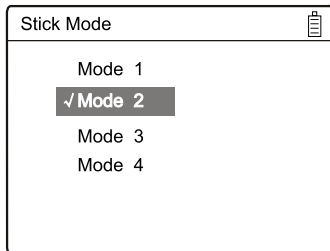

MODE 2 and MODE 4 are listed in left-hand throttle.

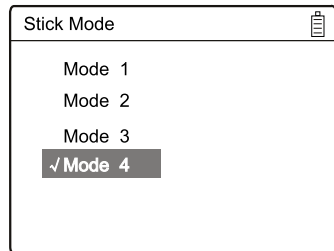

Through the mechanical and electronic swith,the right hand throttle switch to the left hand successfully and can be used normally.

8.2 Left-hand throttle switched to right-hand throttle

(1) Mechanical switch

Refer to the above “Mechanical switch” to open the transmitter cover.

See the following pictures to learn the internal conditions of the left and right hand stich. Then use a Phillips screwdriver to release the connecting rod fixed screw\screw F\screw G and throttle arresting slices in the left hand throttle position,and fix them up in the corresponding right hand Throttle position.According to personal feeling to adjust screw F(adjust the Throttle stick to desired tention),then fixed up the transmitter back cover.

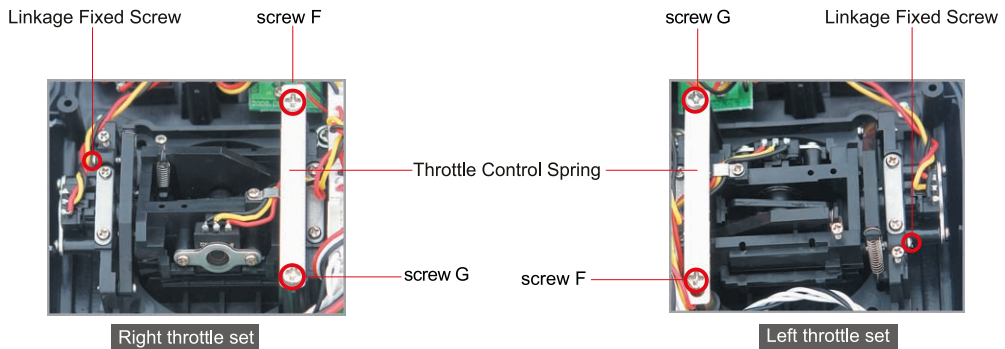

(2) The data switch

Refer to the steps of “8.1 right hand throttle switch to the left hand, (2)electric switch”, access to “stick model”. The left hand throttle switch to the right hand. There are 4 stick models can be choosed at the stick position. Press UP\DN to choose “model 1\3” and confirm via ENT key,make a mark “✓” before the choosed mode. Press EXT to exit after setup complete. The data can be switched automatically.

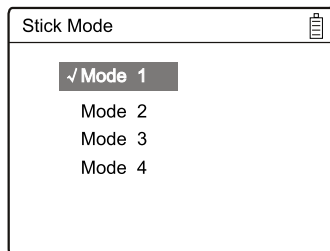

MODE 1 and MODE3 are listed in right-hand throttle.

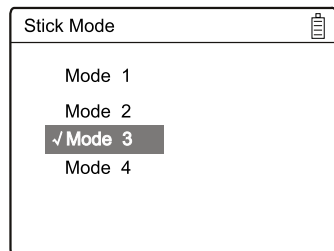

The switch from left hand throttle to right is completed and your DEVO F12E is ready for normal flying.

Note: Pay attention to the strength when removing and adjusting the screws. Excessive strength may damage them.

9.0 Training function

Two DEVO F12E transmitters working together can execute the training function to meet the requirements for the beginner. The setting method is shown as below:

(1) Data copy

First, use the wireless copy function between two DEVO F12E to copy the main transmitter's model data to the trainee's transmitter, this promise the model data between two transmitters is same. Refer the copy method to the second part of helicopter "2.4 model wireless copy" and do the following steps:

(2) Linkage

Insert the digital signal wire from the trainer's transmitter into the DSC socket of the trainee's transmitter. Turn on the transmitter and a linkage icon will be shown on the boot screen.

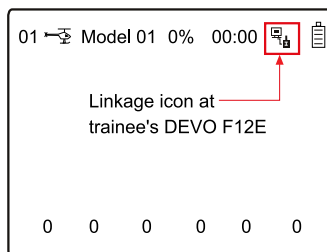

linkage icon

Turn on the power of the trainer's radio. Find out the trainee's model data, and then let the trainer's Radio bind with the aircraft model and fly it normally. Then turn off the power. Insert the other end of the digital signal wire into the trainer's DEVO F12E, and then turn on its power. A linkage icon will be shown as below:

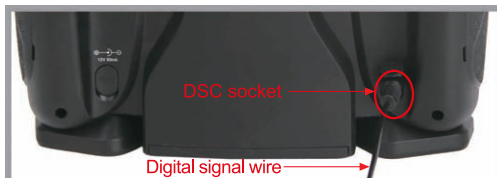
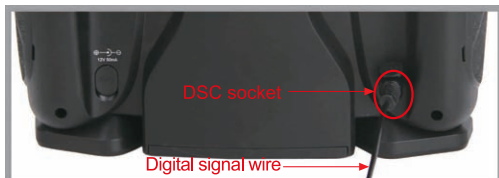

Trainer icon

Training status display: when the trainer's icon becomes into "X", the trainee stops flying and the trainer is working; when the trainer's icon turns into "✓", the trainee is flying and the trainer is in leisure.

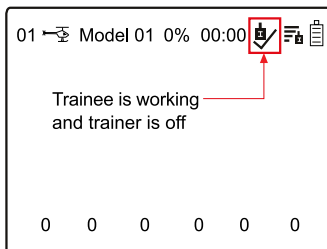
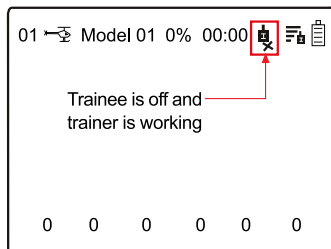

(3) Usage method

The training switch can be freely switchable between left trim and right trim. The default setting is right trim, see as the right illustration.

During flight, if the trainer pushes Right Trim once, the linkage icon will be shown as "✓" that means the control right is moved to the trainee from Trainer. If trainer pushes Right Trim once again, the linkage icon will be shown as "X" that means the trainer takes back the control right from the trainee.

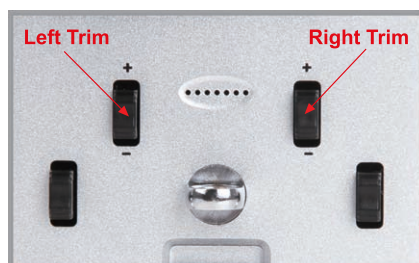

(4) Setting for training function channels

Trainee is available to get full or part of flight control power to the aircraft model via setting the training function channel in the trainer's radio. Below is the setting method:

Press the ENT to enter Main Menu, and then press UP or DN to move the navigational mark to select Function Menu. Then press ENT to enter the Function Menu and press UP or DN to select "Trainer", then press ENT to enter the Trainer interface. The available channels are shown below, and the current status of trainer switch is also shown there.

Trainer	
Switch	Right Trim
Elevator	Inhibit
Aileron	Inhibit
Throttle	Inhibit
Rudder	Inhibit
Gear	Inhibit
Pitch	Inhibit
Gyro	Inhibit

Trainer switch selection: Press UP or DN to select the switch option; press R or L to select the switch which you want. It includes right and left trim. The default setting is Right trim.

Channel selection: Press UP or DN to select the channel option; Press R or L to select the channel(s) which you want to grant to trainee. The channel(s) you have selected will be activated as "Active". The channels which are not granted to trainee will be kept inhibited. The default setting is "Inhibit".

Press EXT to exit.

10.0 Customized fixed ID

This setting will bind DEVO F12E with its receiver in a unique corresponding relationship. It will greatly speed up the time of automatic binding when DEVO F12E powered on.

(1) Setting for fixed ID

The setting for fixed ID should be under the status that automatic ID binding is successfully finished. Below is the setting method.

Press ENT to enter the main Menu and press UP or DN to move the navigational mark to select Model menu. Press ENT to enter Model Menu. Press UP or DN to select Fixed ID and press ENT to enter the Fixed ID setting interface. (Fig. 1)

If you want to activate the fixed ID settings, press R or L to change the status from off to ON. A series of random digits will be shown below after change to On. (Fig. 2)

Press UP or DN to choose the ID code setting, press R or L to choose the digits, press UP or DN to move to the next code setting. There are 6 digits can be set. (Fig. 3)

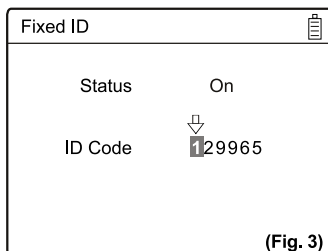
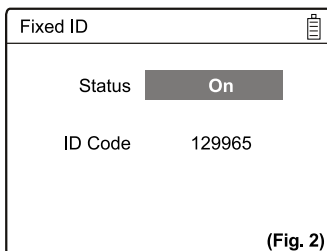
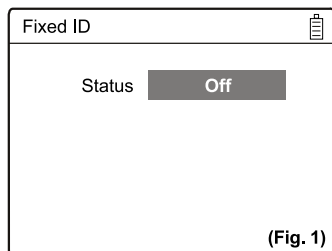

Press ENT key after the new ID has been set. An inquiry interface of "Are you sure?" pop up. "ID Code Matching" will be shown after press ENT. After matching, the interface will be returned to Model Menu.

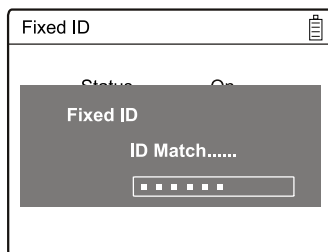
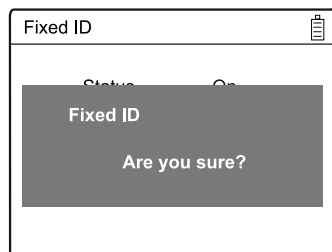

(2) Fixed ID cancellation

Insert the assorted BIND PLUG into the output terminal of BATT before the receiver is powered on, and then plug 5V DC power into other output terminal. The red light of receiver will flash slowly. This means the fixed ID code has been cancelled. Pull out bind plug. DEVO F12E also needs to make relative cancellation and revision after the fixed ID in receiver is cleared out.

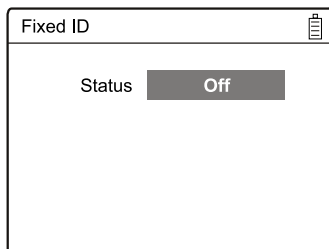

In the main interface press the ENT to enter Model Menu and then press UP or DN to move the navigational mark to select Model Menu. Press ENT to enter Model Menu. Press UP or DN to select Fixed ID code and press ENT to enter the Fixed ID code interface. Press UP or DN to select Status option, Press R or L to change the status to Off. Then press EXT to exit.

11.0 Installation requirement for receiver

- (1) It is important to correctly mount your radio system in your model. Below are some advices on how to install your equipments.
- (2) Wrap the receiver with 10mm thickness polyfoam and fix it with a rubber band or magic string on your helicopter or airplane. It helps protect the receiver.
- (3) It is necessary for you to use rubber grommets and copper sleeves to isolate the vibration from the main body. The mounting screws cannot be over-tightened. Otherwise, the rubber grommets will be distorted and decrease the vibration absorption effect.
- (4) When mounting the servos, make sure the servos' bell cranks can move freely over their whole travel range and ensure the control linkages don't touch or impede the movement of the servos.
- (5) If installing various switches, please keep them far away from the engine tuned pipe and high vibration sources. Ensure all the switches move freely over their whole range.
- (6) Don't make the receiver antennas wrapped or parallel, keep the two antennas form 90 degrees angle.



11.1 Receiver Frame rate setting

There are 11 Millisecond and 22 Millisecond Frame Rate. When using 11 Millisecond frame rate, it can't be compatible with Analog servos. Please select the 22 Millisecond Frame Rate if use Analog servos.

(1) LED Indicator

- Red LED indicates 22ms frame rate;
- Blue LED indicates 11ms frame rate;
- Red&Blue LED indicate the frame rate is under setting;
- Red& Blue LED flash means both frame rate can be set;

(2) Setting method

After TX and RX binding, press the switch with the tool pen or screwdriver, both indicators will turn on. About 5 seconds, both indicator will flash, then release the switch and press it once again, the frame rate can be changed and the indicators will turn red or blue only. Red means 22ms frame rate and Blue means 11ms.

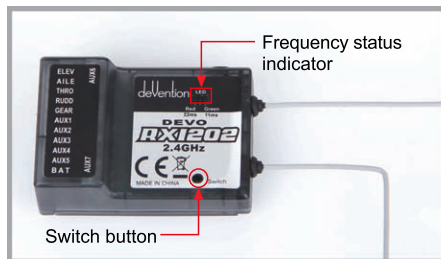

12.0 Installation requirement for DEVO F12E battery pack

Install the DEVO F12E transmitter battery, show as below picture, offering three kinds of power supply sockets, plug according to the power fool-proof plug. The battery can be 7.4V Li-po battery or 11.1V Li-po battery. The size of battery box: 38x31x100mm.

Warning: Do not put the polarities of batteries in the opposite directions.

When insert the battery box connector to the transmitter connector, pls make sure the fool-proof is right, showing as below picture.

- 3pcs Li-po battery balance head power socket
- 2pcs/3pcs Li-po battery JST plug power socket
- 2pcs Li-po battery balance head power socket

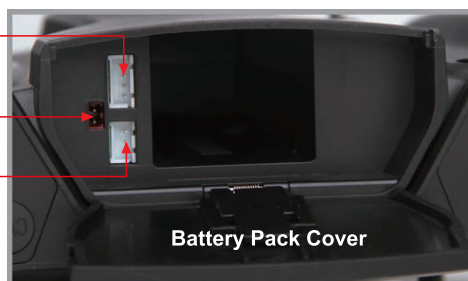

Note: If you don't use the transmitter, please take out the battery.

12.1 DEVO F12E Battery Charging

Warning: the CHG socket is only used for the rechargeable NIMH batteries. If using the batteries which is unchargeable. The CHG socket is not allowed to use.

CHG Charge socket: input DC at 12V, 50mA; Polarity: ⊕ → ⊖



deVention

DEVO F12E

Part two Helicopter

All the functional settings, which are relative to the operation system of DEVO F12E itself, are fully integrated in System Menu. They include Language, Display, Buzzer, vibrator, Video Setting, Stick Mode, Stick Direction, Stick calibration, Battery and About.

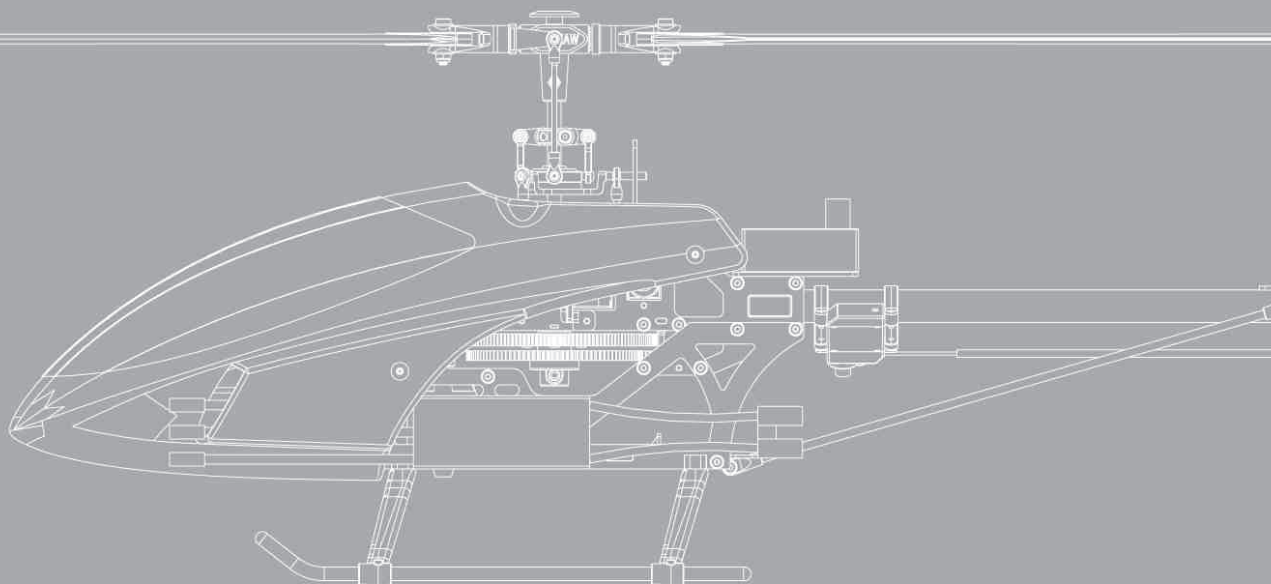

1.0 System Menu

All the functional settings, which are relative to the operation system of DEVO F12E itself, are fully integrated in System Menu. They include Language, Display, Buzzer, Vibrator, Video Setting, Stick Mode, Stick Direction, Stick calibration, Battery and About.

Below is the boot screen of helicopter(e.g throttle stick on the right):

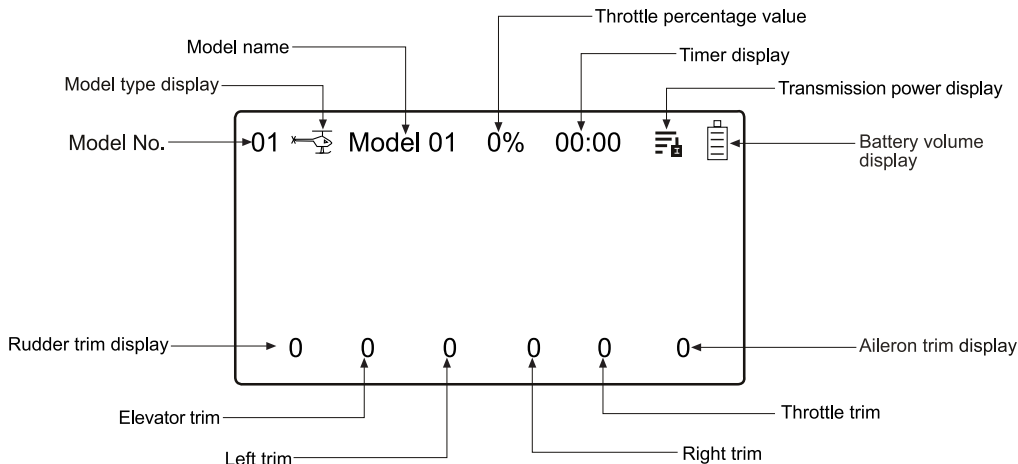

1.1 Language setting

Press ENT to the Main Menu, press UP or DN to select System Menu, then press ENT to System Menu.

Press UP or DN to select "Language" and press ENT to the Language setting interface. Press UP or DN to select the language that you want. A "✓" will be shown on the screen after selected. Press EXT to exit.

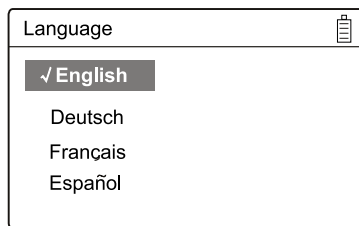

1.2 Display

Press ENT to the Main Menu, press UP or DN to select System Menu, then press ENT to System Menu. Press UP or DN to select "Display" and press ENT to the Display setting interface. Press UP or DN to select the needed setting and press R or L set.

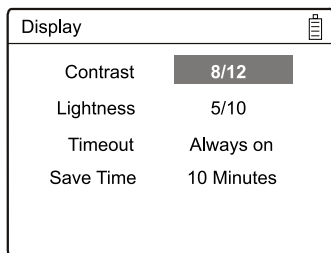

Three items are available to be set. Below are the setting methods for them:

- (1) Backlight contrast: the backlight contrast is adjustable by pushing UP or DN to move the navigational mark to the digits after Contrast. Press R key to increase the backlight contrast, while press L to decrease it.
- (2) Backlight lightness: the backlight lightness is adjustable by pressing UP or DN to move the navigational mark the digits after Lightness. The power consumption will be increased if the backlight lightness is too bright and the battery cruise duration will be shortened. Press R or L to increase or decrease the lightness. When the value is one means turn off the backlight.
- (3) Backlight timeout: it is possible to set the duration which LCD stays at highlight in the form of "Always on" or any period from 5 to 60 seconds with an interval of 5 seconds. Press UP or DN to move the navigational mark to select the digits after Timeout. Press L to short the time of backlight duration or keep it in the form of "Always on" while push R or prolong the time. The maximum is 60s.

(4) Save Time: the Save time setting can set extinguish time when there is no operation on screen, can save the power, and extend the using time of the battery, can also set as always lighting.

Press UP or DN to select the number behind the Save time, Press R can make the always lighting longer, the longest time is 30mins; Press L can reduce the always lighting time or always open. Press EXT to exit.

1.3 Buzzer warning

Press ENT to the Main Menu, press UP or DN to select System Menu, then press ENT to System Menu. Press UP or DN to select "Buzzer" and press ENT to the Buzzer setting interface. Press UP or DN to select the needed setting and press R or L set.

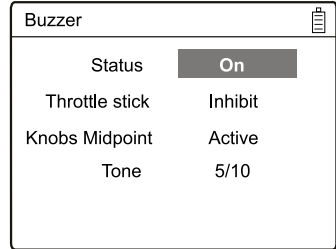

- (1) Status: there are On and off two status on the Buzzer interface. Pressing UP or DN to move the navigational mark to the status option. Pressing R or L to change the On or Off status. It includes Throttle stick, knobs Midpoint and Tones items under the status is On.
- (2) Throttle stick buzzer: Press UP or DN to move the navigational mark to Throttle Stick item then press R or L to change the status from Inhibit to Active. When Buzzer is at the status of On, if Throttle Stick is set as "Active", there is buzzer sound when you push the throttle stick to the midpoint. If you don't need the buzzer sound, please change the status to Inhibit.
- (3) Knobs midpoint Buzzer: When Buzzer is at the status of On, if Knobs is set as "Active", there is buzzer sound when you turn the AUX4 and AUX5 to the midpoint. If you don't need the buzzer sound, please change the status to Inhibit.
- (4) Buzzer tone: the tone is composed of 10 grades. You can choose the favorite one according to your interests. Press UP or DN to move the navigational mark to Tone item and press R or L to make a listening test. Press EXT to exit.

1.4 Vibrator

The vibrator used as an alarm function to remind the users.

Press ENT to get the Main Menu, press UP or DN to select System Menu. And then press ENT to get System Menu, press UP or DN to select Vibrator. Press ENT to get Vibrator setting interface. There are two status as Inhibit and Active. Press R or L to select Active if need. Press EXT to exit after finished.

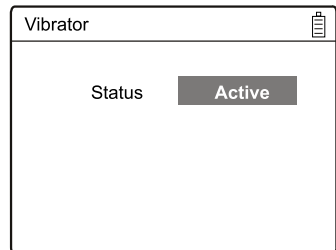
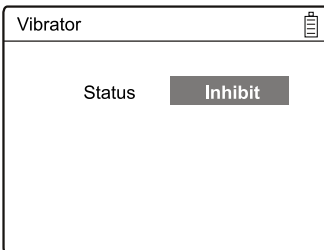

1.5 Video Setting

Press ENT to get the Main Menu, press UP or DN to select System Menu. And then press ENT to get System Menu, press UP or DN to select Video Setting. Press ENT to get Video setting interface. Press R or L to select Inhibit or Active.

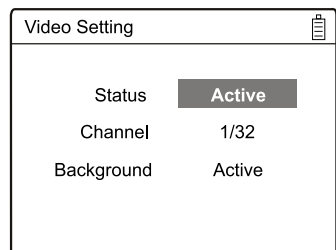
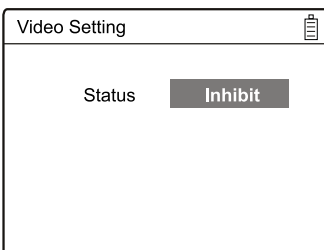

Welcome to use the DEVO F12E transmitter

- 1) Status Selection: choose Inhibit to inhibit video show; choose Active to active video show and the interface will extend 32 channels for selection.
- 2) Channel Selection: choose the corresponding channel of 5.8G transmitter module then the background will show the image which it receives.
- (3) Background: there are two selections Inhibit and Active. Choose Active to show the image in the main interface as the background. Press EXT to return main interface after having finished the settings. In the main interface, press EXT to enjoy the full screen display.

1.6 Stick Mode

Press ENT to get Main Menu, press UP or DN to select System Menu, and then press ENT to the System Menu, press UP or DN to select Stick Mode, and press ENT to get stick Mode setting interface.

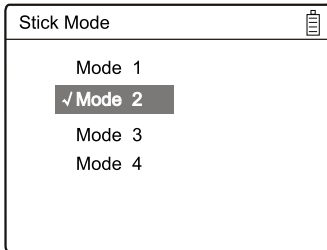

MODE 2 and MODE 4 are listed in left-hand throttle.

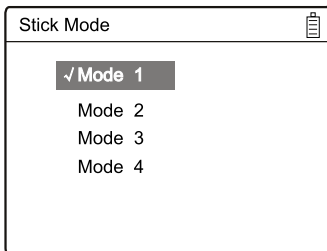
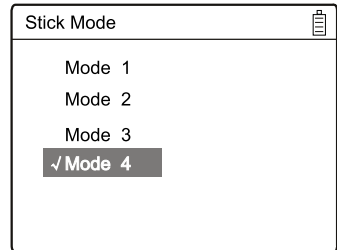

MODE 1 and MODE3 are listed in right-hand throttle.

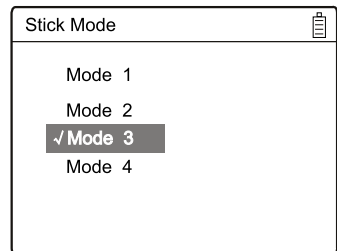

Select the stick mode according to the throttle mode showing on the screen. DEVO F12E offers 4 stick modes, please refer to "8.0 Switches exchange between left-hand and right-hand throttles. Press EXT to exit after finished.

1.7 Stick Direction

Press ENT to get Main Menu, press UP or DN to select System Menu, and then press ENT to the System Menu, press UP or DN to select Stick Direction, and press ENT to get stick direction setting interface.

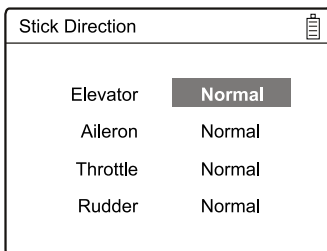

Stick Direction: There are four items available as Elevator, Aileron, Throttle and Rudder. Press UP or DN to select the stick which will change direction, and press R or L to change the direction. The factory setting is Normal.

1.8 Stick Calibration

It is a function to re-calibration when stick unusual.

Calibration method:

Press "ENT" to the Main Menu, press UP or DN to select System Menu, then press ENT to System Menu. Press UP or DN to select Stick Calibration and press ENT to the Stick Calibration setting interface.

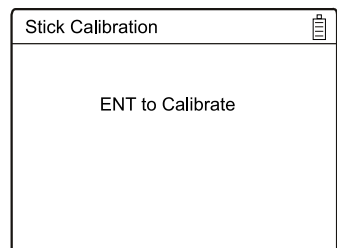

Press ENT button to enter the calibration, Repeat to shark the left and right of the remote control sticks from the rock bottom to highest respectively for several times and then back to the rocker. Press ENT to confirm , if your action is wrong, will display "please Retry!" ; If correct, display "calibration success!" . And then press EXT exit.

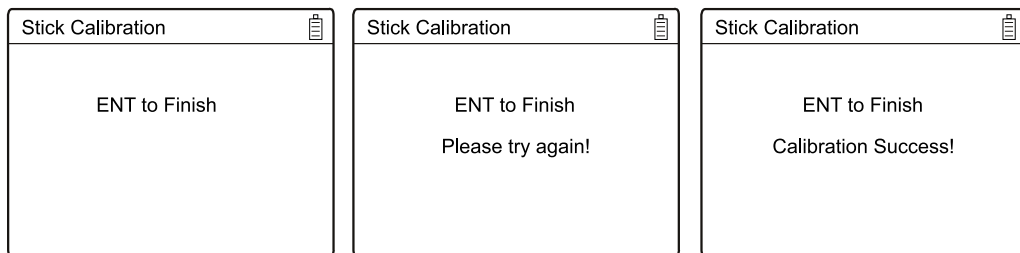

1.9 Battery

Battery voltage can set up the warning value for radio battery in lower voltage.

Press ENT to the Main Menu, press UP or DN to select System Menu, then press ENT to System Menu. Press UP or DN to select "Battery" and press ENT to the Battery setting interface. Warning voltage value can be changeable by R or L button.

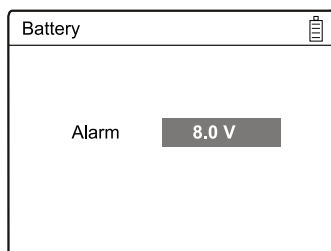

Low Voltage Warning: Please set up the low voltage warning value when you turn it on following the battery specification.

Battery voltage	Li-Po battery 7.4V	Li-Po battery 11.1V	Dry battery 8x1.5V
Advised warning voltage	6.4V	9.6V	8.0V

1.10 About

Press "ENT" to the Main Menu, press UP or DN to select System Menu, then press ENT to System Menu. Press UP or DN to select About and press ENT to the About setting interface.

Press EXT to exit after finished.

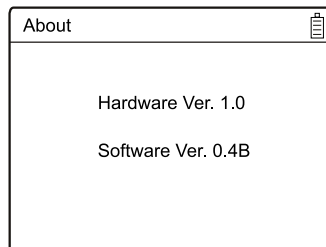

2.0 Model Menu

Model Menu manages all the model data saved in DEVO F12E. It includes Model Select, Model Name, Model Copy, Model Transmit, Model Receive, Model Reset, Type Select, Trim System, Stick Position Switch, Device Select, Device Output, Swash Type, Power Amplifier, Fixed ID and Sensor setting.

2.1 Model Select

Press ENT to enter Main Menu and press UP or DN to make Model Menu is selected. Press ENT to get the Model Menu and press UP or DN to select Model select, press ENT to enter the Model Select setting interface.

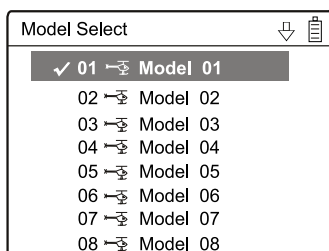

Press UP or DN to select the model you desired, press ENT to confirm and marks "✓" in the front of selected one. Total 15 models are optional, used to save the model data. Press EXT to exit after finished.

2.2 Model Name

In the menu of model name, you can make a desired name for your model for long term storage. Its data can be directly withdrawn in next flights. Repeat the step "2.1 Model Select" to choose the model you want to name or save, press EXT to back to the interface.

Press "ENT" to enter Main Menu, press UP or DN to select "MODEL Menu", then Press "ENT" to enter Model Menu; Press UP or DN to select "Model NAME" and then press "ENT" button to enter the "Model Name" setting interface.

Press UP or DN to select the character and figure which are needed to be changed, press R or L button to change the character and figure, and press UP or DN to set next one. Press EXT to exit after finished.

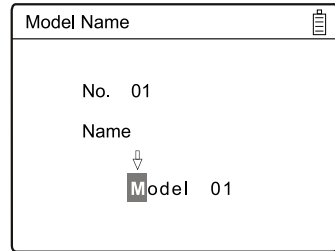

2.3 Model Copy

Press ENT to enter "Main Menu" and press UP or DN to make "Model Menu" is selected. Press ENT to enter "Model Menu" and press UP or DN to select "Model Copy", press ENT to the "Model Copy" setting interface as picture (1).

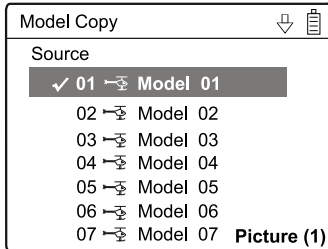

Press UP or DN to choose the source of model copy, press ENT to confirm then you can see the Destination selection as picture (2).

Press UP or DN to choose the destination of model copy, press ENT to confirm then you can see the ask interface as picture (3). Press ENT to execute the operation and return to model menu. Press EXT to exit if not need to execute the operation.

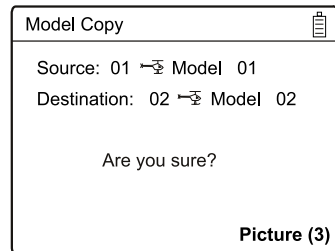
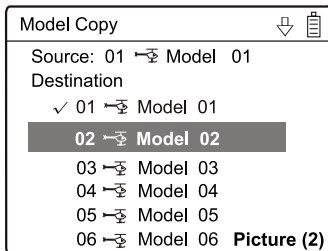

2.4 Model wireless copy

The model data between two DEVO F12E equipments can be wirelessly copied via Model Transmit and Model Receive in Model Menu.

(1) Model transmission

Press ENT to enter "Main Menu" and press UP or DN to select "Model Menu". Press ENT to enter "Model Menu" and press UP or DN to select "Model transmission", continue to press ENT to enter "Model Transmit" setting interface.

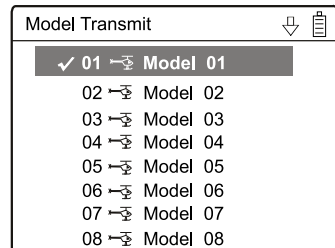
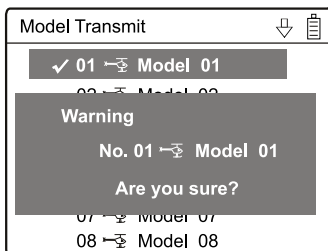

Press UP or DN to choose the source model which will be transmitted, and press ENT to confirm, an enquiry information "Are you sure?" will be shown as left Illustration.

Press ENT to transmit, "Transmitting" appears in the interface. Or press EXT to exit. Press EXT to exit after another DEVO F12E received the data.

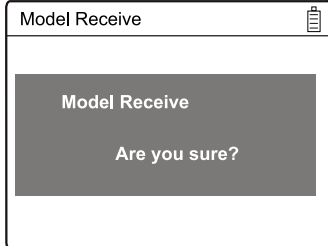
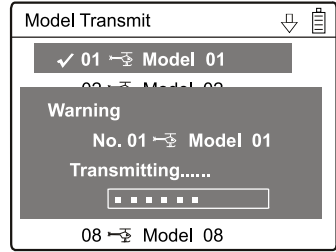

(2) Model receiving

Press ENT to enter Main Menu and press UP or DN to select Model Menu. Press ENT to get Model Menu and press UP or DN to select Model Receiving, continue to press ENT to enter Model Receive setting interface. An enquiry information "Are you sure?" will be shown as left Illustration.

Press ENT to receive, "Connecting" and "Receiving" will be shown in series in the interface. The information of "Received" with the model name will be shown after receiving is finished. Or press EXT to exit.

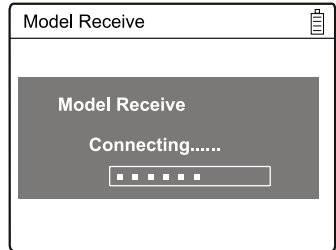

Press UP or DN to choose the save position, an enquiry information "Are you sure?" is shown after press ENT. Press ENT to save or press EXT to exit.

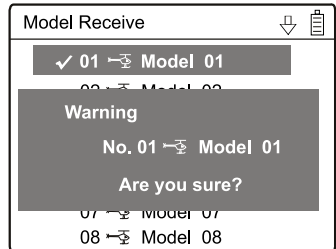
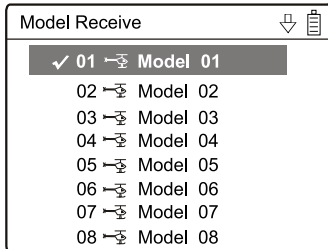

2.5 Model reset

All the model data can be restored to factory settings via Model Reset.

Press the ENT to enter Main Menu and press UP or DN to select Model Menu. Press ENT to get Model Menu and press UP or DN to select Model Reset, press ENT to enter Model Reset setting interface.

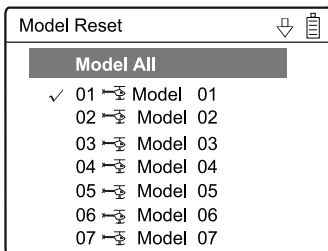

It is possible to store up to 15 models data in the model list of DEVO F12E equipment. There are two methods to reset the model data: batch reset and single reset.

Batch reset: press UP or DN to select Mode All, an enquiry information "Are you sure?" will be appears in the interface. Press ENT to reset all models, or press EXT to exit.

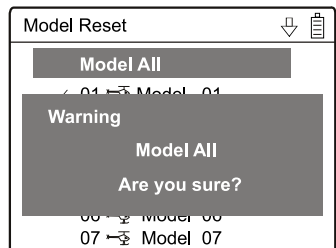

Single reset: Press UP or DN to choose the model you want to restore, “Are you sure?” will appear after press ENT. Press ENT to reset or press EXT to exit.

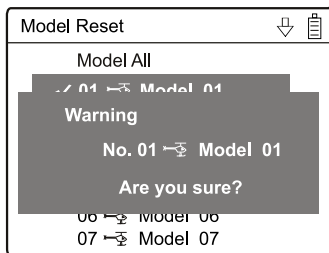

2.6 Type Select

This device offers three model types menu. They are Helicopter, Airplane and Glider respectively.

Press ENT to enter Main Menu and press UP or DN to select Model Menu. Press ENT to enter and press UP or DN to select Type Select and press ENT to enter setting interface.

Press “ENT” button to get Helicopter, Airplane and Glider selections and press UP or DN to select and press ENT to confirm, then press EXT to exit.

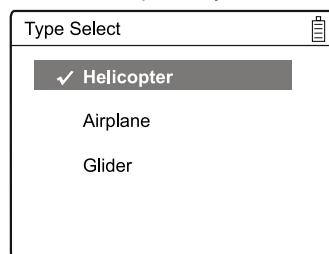

2.7 Trim System

Trim System is able to finely tune the following six items, respectively: Elevator, Aileron, Rudder, Throttle, Left Trim and Right Trim. The trim range is divided into 20 grades (factory default is set at 4). It is convenient to subtly modify the pitch by adjusting the trim range.

Press ENT to enter Main Menu and press UP or DN to select Model Menu. Press ENT to enter and press UP or DN to select Trim System, press ENT to enter Trim System setting interface. Press UP or DN to select the trim which will set, press R to increase the trim value and press L to decrease.

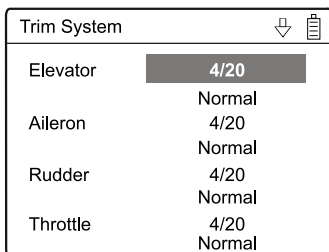

For elevator, aileron, and rudder, there are two more options: Normal and Limited, press R or L you can change the setup. “Normal” means the trim is always working although the corresponding stick stays anywhere. “Limited” means the trim is out of working when the corresponding stick is at maximum position.

Press EXT to exit after finished.

2.8 Stick Position Switch

According to the following setting, the switch can be used as a switch. The turn-on or turn-off position at which stick stays can also be settable.

Method for setting:

Press the ENT to enter Main Menu and press UP or DN to select Model Menu. Press ENT to get Model Menu and press UP or DN to select Stick Position Switch, press ENT to enter Stick Position Switch setting interface.

There are four options under the Stick position switch: SPS0, SPS1, SPS2, SPS3. Press R or L to choose the switch you want to define.

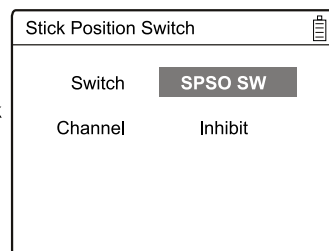

Press UP or DN to inhibit channel in navigation mark, and press R to expand the menu. The channel includes four items: Elevator, Aileron, Throttle and Rudder. The factory default is Inhibit. Take Elevator for example.

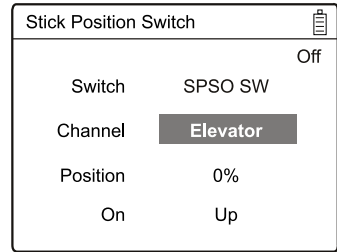
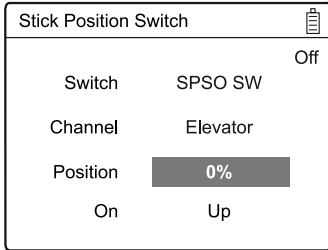

Press R or L to choose the Elevator as stick, then Press UP or DN to move navigation mark to value of position. It's possible to adjust the stick position via pressing R or L.

Press UP or DN to navigate the On setting, press R or L to change the direction of the channel stick.

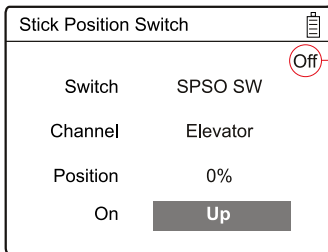

Off — Display of stick position switch status

Moving the stick to make sure that the direction of stick's turn-on or turn-off position is correct.

After finished the setting, press EXT to exit.

2.9 Device select

This setting can help you configure various functional switches, or adjust levers. It includes Flight Main Switch, Flight Extra Switch, Stunt Trim, Hold Switch, Hovering Pitch, Hovering throttle.

Press ENT to enter Main Menu, press UP or DN to move navigation mark to select Model menu. Press ENT to enter Model menu. Press UP or DN to Device select Option. Press ENT to Device select Option interface.

(1) Flight Main Switch:

Press UP or DN to move navigation mark to Flight Main Switch and press R or L to select the desired switch. The factory default setting is FMODE switch.

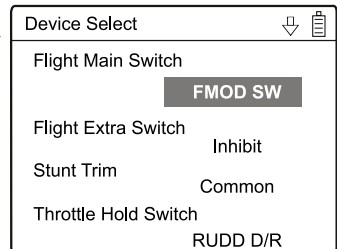

(2) Flight Extra Switch:

Press UP or DN to move navigation mark to Flight Extra Switch and press R or L to select the desired switch. The factory default setting is Inhibit.

(3) Stunt Trim:

There are two modes: Common and Flight Mode. In Common Mode all the trim values, which various sticks are corresponding to, put equal effect on all the flight modes. In Flight Mode, the trim value, each of which stick is corresponding to, puts independent effect on the corresponding stick. The factory default setting is Common.

Press UP or DN to choose the Stunt trim, press R or L to select "Common" or "Flight Mode", the factory default setting is "Common".

(4) Throttle Hold Switch: Refer to "(1) Flight Main switch"

(5) Hovering pitch: Refer to "(1) Flight Main switch"

(6) Hovering throttle: Refer to "(1) Flight Main switch"

After finishing the setting, press EXT to exit.

2.10 Device Output

Device output can set up the output switches respectively. It can also activate, inhibit or use other functions. There are eight items in total: FMODE switch, MIX switch, ELEV D/R switch, AILE D/R switch, RUDD D/R switch, GEAR switch, SPS0, SPS1, SPS2, SPS3, left trim, right trim, AUX4 KB, AUX5 KB, AUX6 KB, AUX7 KB.

Setting:

Press ENT to enter main menu, press UP or DN to move navigation mark to Model Menu. Press ENT to enter Model Menu. Press UP or DN to select Output Device and press ENT to enter Output Device interface.

There are 7 settings: Gear, AUX2, AUX3, AUX4, AUX5, AUX6, AUX7.

(1) Gear

Press UP or DN in output interface can change the gear switch. It includes FMODE, MIX, ELEV D/R, AILE D/R, RUDD D/R, GEAR, SPS0, SPS1, SPS2, SPS3, Left trim, Right trim, AUX4 KB, AUX5 KB, AUX6 KB, AUX7 KB. Press R or L to select the setting switch, The default setting is GEAR SW.

Device Output	
Gear	GEAR SW Active
Pitch	System Active
AUX2	FMODE SW Gyro
AUX3	RUDD D/R Active

Device Output	
Gear	GEAR SW Active
Pitch	System Active
AUX2	FMODE SW Gyro
AUX3	RUDD D/R Active

Press UP or DN to select Function Setting after you select the switch, Press R or L can enter the interface of Gear Inhibit, Active, Gyro, Governor and Pitch. The default setting is Active. You can continue to set other items after finishing.

(2) Pitch: the item is programmed as system default. Any setting is unavailable.

(3) AUX 2

Press UP or DN to enter the AUX2 interface. Press R or L can change the AUX2 switch. It includes FMODE, MIX, ELEV D/R, AILE D/R, RUDD D/R, GEAR, SPS0, SPS1, SPS2, SPS3, Left trim, Right trim, AUX4 KB, AUX5 KB, AUX6 KB, AUX7 KB. The default setting is FMODE switch.

Device Output	
Gear	GEAR SW Active
Pitch	System Active
AUX2	GEAR SW Gyro
AUX3	RUDD D/R Active

Press UP or DN to select the Function Setting, press R or L to choose the switch, it includes Inhibit, Active, Gyro, Governor and Pitch the default setting is Gyro. You can continue to set others items after finishing .

(4) AUX3

Press UP or DN to enter AUX3 interface. Press R or L can change the AUX3 switch. It includes RUDD D/R, GEAR, SPS0, SPS1, SPS2, SPS3, Left trim, Right trim, AUX4 KB, AUX5 KB, AUX6 KB, AUX7 KB. The default setting is RUDD D/R switch.

Press UP or DN to move navigation mark to Function Setting. Press R or L to desired item. The optional items are Inhibit, Active, Gyro, Governor and Pitch. The factory default is Active. Continue to set up other items after setting finished.

Device Output	
Gear	GEAR SW Active
Pitch	System Active
AUX2	GEAR SW Gyro
AUX3	RUDD D/R Active

(5) AUX4, AUX5, AUX6, AUX7 settings please refers to AUX3 settings. AUX4 default setting is AUX4 KB; AUX5 default setting is AUX5 KB; AUX6 default setting is AUX6 KB; AUX7 default setting is AUX7 KB.

After finishing the setting, press EXT to exit.

2.11 Swash Type

The swash type is grouped into six options: 1 Servo Normal, 2 Servos 180°, 3 Servos 120°, 3 Servos 140°, 3 Servos 90° and 4 Servos 90°.

Press ENT to enter Main Menu, press UP or DN to move navigation mark to Model Menu. Press ENT to enter Model Menu. Press UP or DN to select Swash Type and press ENT to enter Swash Type interface.

Press UP or DN to choose the required "Swash type", press ENT to confirm, the corresponding items will have the "✓" mark in front of the items. Press EXT to exit after finishing.

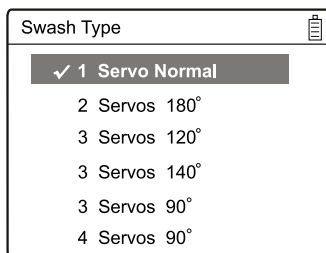

2.12 Power Amplifier

The transmission output power of DEVO F12E is adjustable. It is divided into six grades from small to big. The lower the transmission output power transmits, the shorter the radio range is, and the longer the stand-by time will be, the higher the transmission output power, the farther the radio range, and the shorter the stand-by time. Choose the appropriate transmission output power according to the actual situation.

Press ENT to enter Main Menu, press UP or DN to move navigation mark to Model Menu. Press ENT to enter Model Menu. Press UP or DN to select Power Amplifier and press ENT to enter Power Amplifier interface.

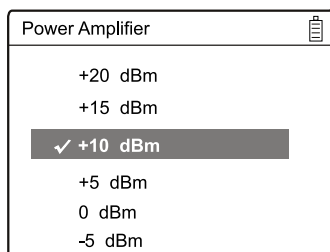

Press UP or DN to choose the desired output power value. Press ENT to confirm then the corresponding items will have "✓" mark in front of the items.

After the setting, press EXT to exit.

Grade 6	Grade 5	Grade 4	Grade 3	Grade 2	Grade 1
20dBm	15dBm	10dBm	5dBm	0dBm	-5dBm

2.13 Fixed ID

This setting will bind DEVO F12E with its receiver in a unique corresponding relationship. It will greatly speed up the time of automatic binding when DEVO F12E powered on.

(1) Setting for fixed ID

The setting for fixed ID should be under the status that automatic ID binding is successfully finished. Below is the setting method.

Press ENT to enter the main Menu and press UP or DN to move the navigational mark to select Model menu. Press ENT to enter Model Menu. Press UP or DN to select Fixed ID and press ENT to enter the Fixed ID setting interface.(Fig. 1)

If you want to activate the fixed ID settings, press R or L to change the status from off to ON. A series of random digits will be shown below after change to On. (Fig. 2)

Press UP or DN to choose the ID code setting, press R or L to choose the digits,press UP or DN to move to the next code setting . there are 6 digits can be setted. (Fig. 3)

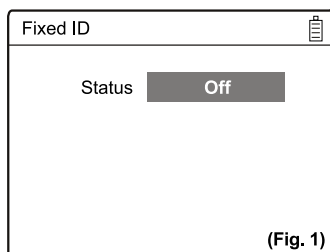

(Fig. 1)

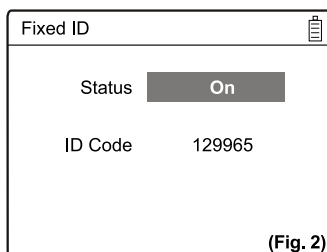

(Fig. 2)

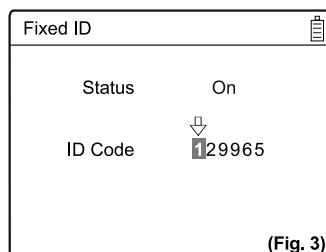

(Fig. 3)

Press ENT key after the new ID has been setted. An inquiry interface of "Are you sure?" pop up. "ID Code Matching" will be shown after press ENT. After matching, the interface will be returned to Model Menu.

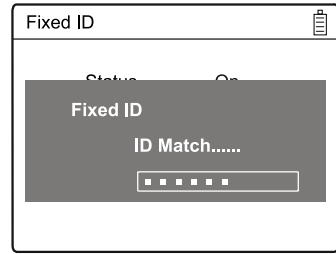
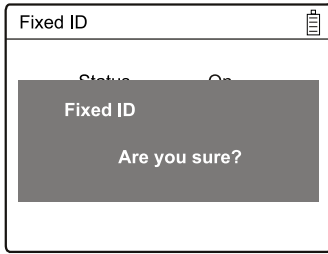

(2) Fixed ID cancellation

Insert the assorted BIND PLUG into the output terminal of BATT before the receiver is powered on, and then plug 5V DC power into other output terminal. The red light of receiver will flash slowly. This means the fixed ID code has been cancelled. Pull out bind plug. DEVO F12E also needs to make relative cancellation and revision after the fixed ID in receiver is cleared out.

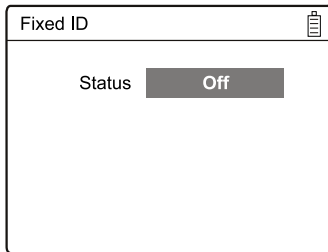

In the main interface press the ENT to enter Model Menu and then press UP or DN to move the navigational mark to select Model Menu. Press ENT to enter Model Menu. Press UP or DN to select Fixed ID code and press ENT to enter the Fixed ID code interface. Press UP or DN to select Status option, Press R or L to change the status to Off. Then press EXT to exit.

2.14 Sensor setting

Setting method: press ENT enter to the Main Menu. Press UP or DN to select the Model Menu. Press ENT enter to Model Menu. Press UP or DN to select sensor press ENT enter to the sensor setting interface. See the Illustration.

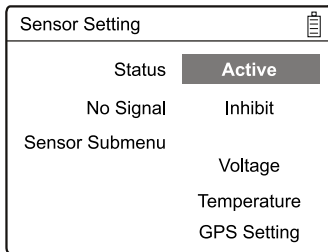

Press R or L to select Activate or Inhibit (the default setting is Inhibit), such as press Activate will includes No Signal Warning, Voltage sensor, Temperature sensor, GPS receiver setting etc.

(1) No Signal

Press UP or DN to make the navigation mark to choose "No Signal ". Press R or L to choose " Inhibit" or "Active"(default setting is" inhibit)". If you choose "Active", the Radio will alarm when telemetry signal lost. Picture as left:

(2) Voltage setting

There are 3 different types of voltage can be measured. It includes Interna:V0, External:V1 and V2 which can be monitored two different external voltage(i.e. battery) respectively. Once the measured voltage is lower than the setting value, the Radio will alarm.

(2.1) Receiver V0(Internal) PFV(Power Feeding Voltage) Alarmed value can be setted as 3.6-6V

Voltage setting: press R or L to activate the V0, the alarm interface will appear in the interface , please refer to the Illustration.

Press UP or DN to select the Alarm Voltage setting, press R or L to set the value. The range is 3.6-6V. you can continue to set other items after you finished.

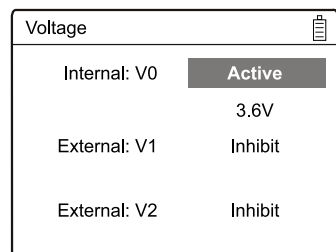
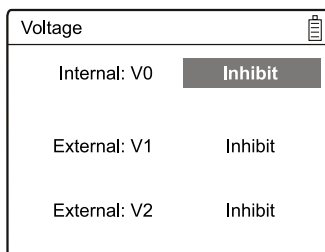

(2.2) External:V1

Press UP or DN enter to External:V1 setting interface. Press R or L to activate the V1, the details refers to the Illustration.

Press UP or DN to select the Alarm Voltage setting. Press R or L to set the value. The setting range is 0.2~99.9V, you can continue to set other items after you finished.

Voltage	
Internal: V0	Inhibit
External: V1	Inhibit
External: V2	Inhibit

Voltage	
Internal: V0	Inhibit
External: V1	Active 0.2 V
External: V2	Inhibit

(2.3) External: V2 setting can refer to External V1 setting.

Press EXT back to sensor setting interface after you finished.

(3) Temperature sensor

The temperature sensor can measure up to 4 different temperature(i.e.motors).You can choose Celsius or Fahrenheit.The alarmed value can be setted to 4 different temperature.Once the measured value is higher than the setting value, the radio will alarm.The Alarm Temperature value can be setted as -20~220℃ or -4.0~428.0° F.

Temperature Setting:

In the “Sensor Setting”interface, press UP or DN to make the navigation mark to choose “Temperature Sensor”, and press ENT to enter “Temperature Sensor”setting interface. See the illustration.

Temperature	
Unit	Celsius
Temp. T1	Inhibit
Temp. T2	Inhibit
Temp. T3	Inhibit

(3.1) Unit

Press UP or DN to make the navigation mark to choose “Unit”setting item, and press R or L to choose Unit, two kinds of Unit:Celsius and Fahrenheit.

(3.2) Alarm Temperature settings

Press UP or DN select the T1, Press R or L to Active the setting. Inhibit will change to Active and Alarm temperature will be shown. If you choose Inhibit, the Alarm temperature value won't be shown.

Temperature	
Unit	Celsius
Temp. T1	Active 100℃
Temp. T2	Inhibit
Temp. T3	Inhibit

Press UP or DN to select “Alarm”setting, press R or L to set the alarm temperature value. Press UP or DN to set other items after finishing the setting.

(3.3) T2, T3, T4 setting

Refer to the step of “(3.2)T1”.

(4) GPS setting

There are 4 items including Altitude Type,Speed Unit, Date Type and Time Zone in the GPS receiver setting interface.

Press UP or DN to select the Sensor setting interface to enter the GPS setting interface.

(4.1) Altitude Type

Press UP or DN to select the Altitude type on the GPS setting interface and it's Absolute and Relative.

GPS Setting	
Altitude Type	Absolute
Speed Unit	Knots
Date Type	DD-MM-YY
Time Zone	UTC+08:00

Welcome to use the DEVO F12E transmitter

(4.2) Speed Unit

Press UP or DN to select the Speed Unit on the GPS setting interface and it includes knots and km/h and relative. Select the desired item.

GPS Setting	
Altitude Type	Absolute
Speed Unit	Knots
Date Type	DD-MM-YY
Time Zone	UTC+08:00

GPS Setting	
Altitude Type	Absolute
Speed Unit	Km/h
Date Type	DD-MM-YY
Time Zone	UTC+08:00

(4.3) Date Type

Press UP or DN to select the Date Type on the GPS setting interface and it includes DD-MM-YY,MM-DD-YY and YY-MM-DD. Select the desired item.

GPS Setting	
Altitude Type	Absolute
Speed Unit	Knots
Date Type	DD-MM-YY
Time Zone	UTC+08:00

(4.3) Date Type

GPS Setting	
Altitude Type	Absolute
Speed Unit	Knots
Date Type	DD-MM-YY
Time Zone	UTC+08:00

(4.4) Time Zone

(4.4) Time Zone

Press UP or DN to select the Time Zone , press R or L to set the desired Time Zone.

3.0 Function Menu

Function Menu can help you custom adjustments for the selected models. The menu include items such as Reverse Switch, Travel Adjust, Sub Trim, Dual Rate and Exponential, Throttle Hold, Throttle Curve, Mix to Throttle,Gyro Sensor, Governor,Tail Curve, Dual Pitch, Swash Mix ,Pitch Curve, Program Mix, Monito ,Fail Safe, Sensor view, Trainer and Timer.

3.1 Reverse Switch

Press ENT to enter Main Menu; Press UP or DN to move the navigation mark to Function Menu. And press ENT to enter Function Menu, Press UP or DN to choose Reverse Switch and Press ENT to enter into Reverse Switch interface.

Reverse Switch	
Elevator	Reverse
Aileron	Normal
Throttle	Normal
Rudder	Normal
Gear	Normal
Pitch	Normal
Gyro	Normal
AUX3	Normal

Press UP or DN to move navigation mark to ELE(take Elevator for example), Press R or L to shift the status between normal and reverse. These are two status for option. And the default setting is Normal. All Channels Reverse Switch like: Aileron, Throttle, Rudder, Gear, Pitch, AUX2, AUX3, AUX4, AUX5, AUX6 and AUX7 can be referred to the way of ELEV Reverse Switch. And press EXT to exit after finishing setting.

Reverse Switch	
Elevator	Normal
Aileron	Normal
Throttle	Normal
Rudder	Normal
Gear	Normal
Pitch	Normal
Gyro	Normal
AUX3	Normal

3.2 Travel Adjust

Press ENT to enter into Main Menu. Press UP or DN to move navigation mark to select item Function Menu. Press ENT to enter Function Menu. Press UP or DN to select Travel Ajust, Press ENT to enter Travel Adjust interface, as left illustration. It shows the Travel Adjust status of one channel.

Travel Adjust	
Elevator	U100.0%
	D100.0%
Aileron	L100.0%
	R100.0%
Throttle	H100.0%
	L100.0%
Rudder	L100.0%
	R100.0%

Take ELEV for example, Press UP or DN to move navigation to desired item Elevation of U. Press R or L to increase or decrease the servo travel range. The adjustment range is from 0.0% to 150.0%. The factory default is 100.0%.

Press UP or DN to move navigation mark to desired item D of ELEV. Press R or L to increase or decrease the servo travel range. The range is from 0.0% to 150.0%. The factory default is 100.0%.

All other channel's Travel Adjust like Aileron, Throttle, Rudder, Gear, Pitch, AUX2, AUX3, AUX4, AUX5, AUX6 and AUX7 can be referred to ELEV travel Adjust. Press EXT to exit after setting finished.

3.3 Sub Trim

Sub Trim can move the neutral point of the servo. But we advise you to mechanically adjust the servo bell crank if offset is far away from the neutral point of servo, because excessive usage of the sub trim may damage the servo.

Setting method:

Press ENT to enter Main Menu, Press UP or DN to move the navigation mark to select item Function Menu. Press ENT to enter Function Menu, Press UP or DN to select Sub trim, and press ENT to enter Sub Trim interface.

Sub Trim	
Elevator	0.0%
Aileron	0.0%
Throttle	0.0%
Rudder	0.0%
Gear	0.0%
Pitch	0.0%
Gyro	0.0%
AUX3	0.0%

The interface show the items and the channels which are adjustable. Press R or L to change the neutral point of Servos. The factory default is 0.0%. Press UP or DN to choose desired items. The range as below:

Channel name	Adjustment range	Channel name	Adjustment range
Elevator	D62.5% ~ U62.5%	Gyro	-62.5% ~ +62.5%
Aileron	R62.5% ~ L62.5%	AUX3	-62.5% ~ +62.5%
Throttle	L62.5% ~ H62.5%	AUX4	-62.5% ~ +62.5%
Rudder	R62.5% ~ L62.5%	AUX5	-62.5% ~ +62.5%
Gear	-62.5% ~ +62.5%	AUX6	-62.5% ~ +62.5%
Pitch	L62.5% ~ H62.5%	AUX7	-62.5% ~ +62.5%

Press EXT to exit after adjustment finished.

3.4 Dual rate and Exponential

After this function is set up, it is possible for D/R switches to control the dual rates of elevator, aileron and rudder, respectively. The setting range is covered from 0% to 125%. Under the help with exponential curve adjustment, it is possible to make both customized setting and automatic setting. The switch between Dual rate and Exponential can be performed via pushing or pulling the Flight Mode Lever.

Setting method:

Press ENT to enter Main Menu. Press UP or DN to move navigation mark to desired item Function Menu. Press ENT to enter Function Menu, press UP or DN to choose Dual rate and Exponential, Press ENT to enter D/R and Exponential interface.

(1) Channel selection

Dual Rate and Exponential	
Pos 0	
Channel	Elevator
Position	Pos 0
Dual Rate	100%
Exponential	Line
Normal Mode	Switch
Stunt 1	Switch
Stunt 2	Switch

Press UP or DN to move navigation mark of Channel, Press R or L to set up channels containing Elevator, Aileron and Rudder. Choose the desired channel for setting.

(2) Position selection

Press UP or DN to move navigation mark to desired item Position.

In the manual mode, the function of Dual rate and Exponential will be executed by the corresponding D/R switch among Pos0 and Pos1. Take the item Elevator at channel as an example. It's possible to shift between Pos0 and Pos1 via pushing or pulling the D/R switch.



Dual Rate and Exponential	
	Pos 0
Channel	Elevator
Position	Pos 0
Dual Rate	100%
Exponential	Line
Normal Mode	Switch
Stunt 1	Switch
Stunt 2	Switch

(3) Dual rate adjustment

Press UP or DN to move the navigation mark to desired item Dual Rate, press R or L to change the number and then the dual rate of the position will be changed. The factory default setting is 100%.

(4) Exponential

Press UP or DN to select Exponential item of navigation mark. It's possible to change Dual Rate and Exponential value in Pos when pressing R or L to change the value. There are ±100% and Line three adjustment.

Dual Rate and Exponential	
	Pos 0
Channel	Elevator
Position	Pos 0
Dual Rate	100%
Exponential	Line
Normal Mode	Switch
Stunt 1	Switch
Stunt 2	Switch

(5) Automatic setting

Under working with Flight Mode, it's possible to switch between the Dual Rate and Exponential, which are set in above"(3) Dual Rate adjustment" and "(4) Exponential adjustment", respectively.



The settings for Normal Mode, Stunt 1, Stunt 2, Stunt 3, Stunt 4 and Throttle Hold are available. But for Stunt 3 and Stunt 4, Flight Mode Extra Switch at Device Select in Mode Menu should be activated(Refer to "2.9 Device Select"), and Throttle Hold in Function Menu should be set as Active(Refer to "3.5 Throttle Hold" below).

(5.1) Normal Flight Mode setting:

Press UP or DN in the navigation mark of Dual rate and Exponential to select the desired item Normal Flight. Press R or L to set the position and the Switch. Only the D/R switch control is valid When Switch is selected, under the Flight Mode, it's possible for Pos to switch the dual rate and exponential, which are set in above(3) and (4)Exponential adjustment. The settings for Switch, Pos0, Pos1, Pos2, Pos3, Pos4 and Pos5 are valid.

Dual Rate and Exponential	
	Pos 0
Channel	Elevator
Position	Pos 0
Dual Rate	100%
Exponential	Line
Normal Mode	Switch
Stunt 1	Switch
Stunt 2	Switch

(5.2) The setting for Stunt1, Stunt2, Stunt3, Stunt4 and Throttle Hold can be set up according to above Normal Flight Setting.

Press EXT to exit after finishing the setting.

3.5 Throttle Hold

If this function is set, the switch will be executed by hold switch. The setting value of throttle hold is ranged from -20.0-50.0%. the default setting is Inhibit.

Setting method:

Press ENT to enter Main Menu, Press UP or DN to move navigation mark to select Function Menu. Press ENT to enter Function Menu. Press UP or DN to select Throttle Hold, Press ENT to enter Throttle Hold interface, as below illustration:

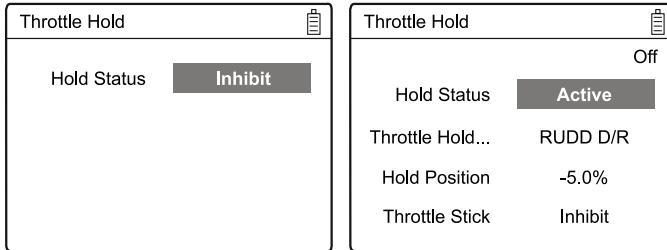

Press R or L to activate Throttle Hold function, and expansion list will be shown as Hold status, Throttle Hold Switch, Hold Position, Throttle Stick.

(1) There are two items under Throttle Hold Status: Active and Inhibit. The factory default setting is Inhibit.

(2) Throttle Switch setting

It's invalid for setting, the factory default is RUDD D/R which will be shown in the status item. When the Throttle Hold switch is on, data under the Throttle Hold can not be amended until Throttle Hold switch to be off, and the hold status is changed.

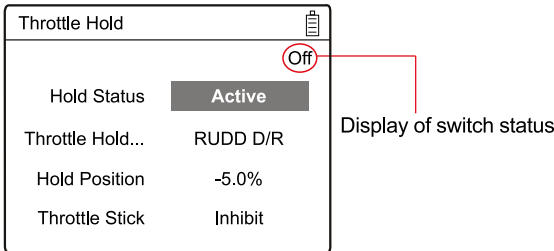

(3) Hold Position

In the Throttle Hold interface, press UP or DN to make the Navigation mark to choose "Hold Position" setting options. Press R or L to change data, the minimum value is -20.0%; the maximum value is +50.0%.

(4) Throttle Stick

on the interface Throttle hold, choosing the Throttle Stick by button UP or DN, press R or L, the expansion list will be shown as Inhibit and Active, default setting is Inhibit, if turning Active, menu "Cut Position" will be seen, you can set it by button UP or DN, data changes will be controlled by R or L, the minimum is 0.0% and the maximum is 100.0%.

Press EXT to exit after setting up finished.

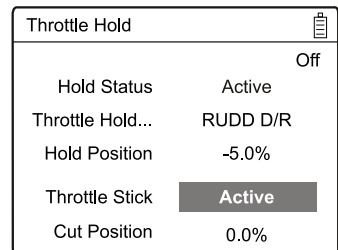

3.6 Throttle Curve

Throttle curve are adjusted through seven points, which of all the flight modes can be respectively set. The flight mode include Normal Flight, Stunt 1, Stunt 2, Stunt 3 and Stunt 4 while Flight Modes Extra Switch in Device Select should be activated(Refer to "2.9 Device Select").

Press ENT to enter main menu, Press UP or DN to move navigation mark to select Function Menu. Press ENT to enter Function Menu. Press UP or DN to select Throttle Curve, Press ENT to enter Throttle Curve interface. The enquiry dropdown is shown "All servos hold?" If select OK, all the servos will be locked at the current status, if click Cancel, all the servos will be unlocked at the current status.

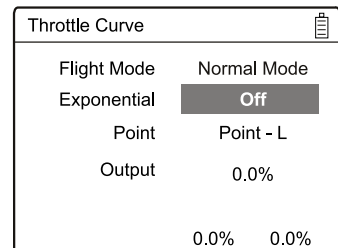
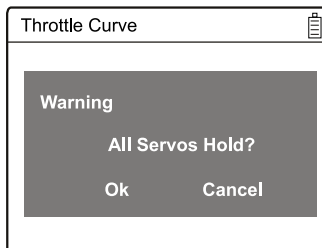

(1) Flight Mode

There are total five flight modes: Normal Flight, Stunt 1, Stunt 2, Stunt 3 and Stunt 4. The Curve of which can be respectively set in their corresponding flight mode. The setting method is to press UP or DN to select Flight Mode in Throttle Curve interface. The corresponding flight mode will be shown when the Flight Mode switch shifts via pushing or pulling the Flight Mode Switch. And the exponential can be adjusted after Flight Mode is selected.

(2) Exponential setting

Press UP or DN in the “Throttle Curve” setting interface to select “Exponential” setting, Press R or L to set “Off” or “On”. The throttle curve will being changed smoothly if select On. Select Off if not need then the throttle curve will be shown as a line.

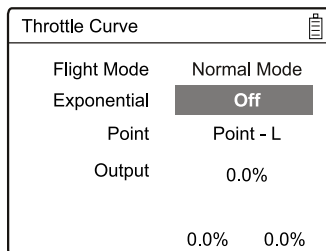

(3) Curve setting

It includes two items: Point and Output.

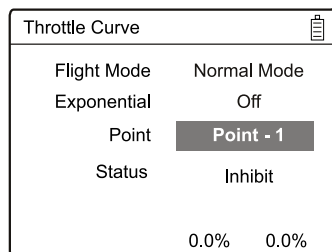

(3.1) Point setting

Press UP or DN in Throttle Curve interface to select Points setting. Press R to expand a list including seven points: “Point-L”, “Point-1”, “Point-2”, “Point-M”, “Point-3”, “Point-4” and “Point-H”. Press R or L to select the point you want to adjust.

(3.2) Status setting

Press UP or DN to move navigation mark to Status and press R or L to choose Inhibit or Activate. Select Inhibit if keeping the current value(the default setting is Inhibit). Select Active for changing the above points' value.

Note: After select point -L or Point-H, the status setting won't be display.

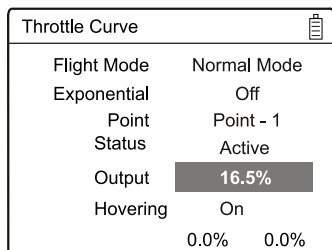
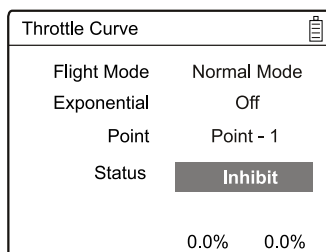

(3.3) Output adjustment

An expansion list of Output and Hover items will be shown after activating the Status. Press UP or DN to move navigation mark to select Output item. And press R or L to increase or decrease the amount of selected point with a minimum of 0.0% and a maximum of 100.0%.

(3.4) Hovering Adjustment

After the setting of (3.3) Output adjustment is finished, it's necessary to set the item of Hovering as On and all the selected points of the throttle curve should be activated if using throttle trim in flight is a must. The five points of 1-2,M,3-4 in the curve will being paralleled or down with the changing of throttle trim. So the throttle curve will being paralleled up or down with the movement of the five points.

Press EXT to exit after finish the setting.

3.7 Mix to throttle

This Function can keep the main rotor blades running at the certain revolution caused by the changed load when operation the aileron servo, elevator servo and rudder servo. Generally, it's not advised to use the function.

Setting method:

Press ENT to enter Main menu. Press UP or DN to move navigation mark to select Function Menu. Press ENT to enter function menu. Press UP or DN to select Mix to Throttle. And press ENT to enter Mix to throttle interface as in below illustration.

Mix to Throttle		
Elevator	Up	0%
	Down	0%
	Switch	On
Aileron	Left	0%
	Right	0%
	Switch	On

There are three settings: elevator, aileron and rudder. If the item of Channel is shown as Elevator, there are UP, DOWN and Switch in the interface. If the item of Channel is Aileron or Rudder, the contents in the said interface will be changed into Left, Right and Switch. Take the example of Channel set as Elevator to illustrate the setting method.

(1) Up setting

In the Mix to throttle interface, press UP or DN to move the navigation mark to select UP item. Press R or L to increase or decrease the mix amount when moving the throttle stick upwards. The bigger the amount is, the bigger the mix to throttle will be. Change the amount from “+” to “-” for the throttle mix direction Reversing. The adjustable range is ±125%.

(2) Down setting

In the interface of Mix to Throttle, press UP or DN to move the navigation mark to select Down item. Press R or L to increase or decrease, respectively, the mix amount when moving the throttle stick downwards. The bigger the amount is, the bigger the mix to throttle will become. Change the amount from “+” to “-” for the throttle mix direction Reversing. The adjustable range is ±125%.

(3) Switch Selection

In the interface of Mix to Throttle, press UP or DN to move navigation mark to select Switch item. Press ENT, an expansion list of Always on, Normal Mode, Stunt 1, Stunt 2, Stunt 3, Stunt 4 and Gear is shown. After setting finished, Aileron or Rudder can be set via pressing DN.

Switch	
<input checked="" type="checkbox"/>	Always On
<input type="checkbox"/>	Normal Mode
<input type="checkbox"/>	Stunt 1
<input type="checkbox"/>	Stunt 2
<input type="checkbox"/>	Stunt 3
<input type="checkbox"/>	Stunt 4
<input type="checkbox"/>	GEAR SW

(4) The setting of Aileron or Rudder, and Mix to Throttle can be referred to Elevator setting. Press EXT after setting finished.

Note:

- (1) Before the flight, please confirm: All above amount of mix to throttle is proper enough to offer a good flight. And make sure all the actions in different flight mode are normal.
- (2) The function is in spare when governor is working.

3.8 Gyro Sensor

This function supply the GYRO sensitivity adjustment, both through switch ‘D/R’ to Manual and “Flight Mode” Automatic switch different sensitivity.

Setting method:

Press ENT to enter Main menu. Press UP or DN to move navigation mark to select Function Menu. Press ENT to enter function menu. Press UP or DN to select Gyro Sensor. And press ENT to enter Gyro Sensor interface.

Gyro Sensor	
Mode	Manual
Channel	AUX2
Switch	MIX SW
Pos 0	50.0%
Pos 1	50.0%
Pos 2	50.0%

(1) Manual Setting

(1.1) Manual Setting

In the Gyro Sensor interface, press UP/DN to choose “mode” project set, press R/L to selectable set (“Manual set” and “Automatic set”). Then choose “Manual” option.

(1.2) Channel

The original channel is “AUX2”, if you want to change to other channels control, you can choose from “Output” set. (refer to “2.10 Output”).

(1.3) Switch choose

In the Gyro Sensor interface, press UP/DN to choose “Switch” project set, press R/L to selectable sets “FMODE SW”, MIX SW, ELEV D/R, AILE D/R, RUDD D/R, GEAR SW, totally 6 selectable sets. Choose the Manual control switch.

(1.4) Sensitivity Setting

If choose 3 switches,there are "position 0", "position 1" and "position 2",then set the sensitivity individually; If choose 2 switches,there are "position 0" and "position 1" , then set the sensitivity individually.

Gyro Sensor		Pos 0
Mode	Manual	
Channel	AUX2	
Switch	MIX SW	
Pos 0	50.0%	
Pos 1	50.0%	
Pos 2	50.0%	

(1.4.1) Pos 0

Turn the choosed GYRO Control Switch, make the status display present switch status "Pos 0" . Press UP or DN to choose "Pos 0", press R or L to increase/decrease value individually. If the GYRO have "NOR" mode and "AVCS" mode, when the value lower than 50%, it is "NOR"mode. The lower of the value is, the bigger of the GYRO sensitivity becomes. The factory default value is 50%.

(1.4.2) "Pos 1", "Pos 2" are the same setting way as above "Pos 0".

(2) Automatic setting

(2.1) Automatic Setting

In the Gyro Sensor interface, press UP or DN to choose "mode" project set, press R or L to selectable sets ("Manual set" and "Automatic set").Then choose "Automatic" option.

Gyro Sensor		Normal Mode
Mode	Automatic	
Channel	AUX2	
Switch	MIX SW	
Normal Mode	50.0%	
Pos 1	50.0%	
Pos 2	50.0%	
Pos 3	50.0%	

(2.2) Channel

The original channel is "AUX2",if you want to change to other channels control,you can choose from "output"set.(refer to "2.10 output").

(2.3) Switch: There is no use in the Automatic Setting.

Gyro Sensor		Normal Mode
Mode	Automatic	
Channel	AUX2	
Switch	MIX SW	
Normal Mode	50.0%	
Pos 1	50.0%	
Pos 2	50.0%	
Pos 3	50.0%	

← Display present flight mode

(2.4) Status

Turn the Switch "flight mode"or "Throttle hold", the status set display present flight mode position. There are Normal Mode, Stunt 1, Stunt 2, Stunt 3, Stunt 4, Throttle hold sets. For Stunt 3 ND Stunt 4, Flight Mode Extra Switch should be activated in Device Select as well as Throttle Hold Switch is set as RUDD D/R.(refer to "2.9 Device Select")

(2.4.1) Normal Mode

Press UP or DN to choose "Normal Mode" project set, press R or L can increase or decrease the value individually.If the GYRO have "NOR"mode and "AVCS"mode, when the value is lower than 50%,it is "NOR"mode. the lower of the value is ,the bigger of the GYRO sensitivity becomes. The factory default value is 50%.

Gyro Sensor		Normal Mode
Mode	Automatic	
Channel	AUX2	
Switch	MIX SW	
Normal Mode	50.0%	
Pos 1	50.0%	
Pos 2	50.0%	
Pos 3	50.0%	

(2.4.2) Stunt 1, Stunt 2, Stunt 3, Stunt 4, throttle hold settings refer to "Normal Mode". After finishing the set, press EXT to exit.

3.9 Governor

Before setup this function, "Governor" should be set and activated in "output" interface. (Refer to 2.10 Output) It is possible to set Governor control rate in various flight modes seperately. Please setup the Governor for the desired rotation speed. The transmitter display data is only for percentage reference. The real rotation speed refer to Governor.

Setting method:

Press ENT to enter Main Menu; Press UP or DN to move make navigation mark to select Function Menu. Press ENT to enter Function Menu; Press UP or DN to choose Governor then through the ENT key to the Governor setting interface, which display the status and channels; Press UP or DN can see the Normal Mode, Stunt 1, Stunt 2, Stunt 3, Stunt 4, Throttle Hold and so on .

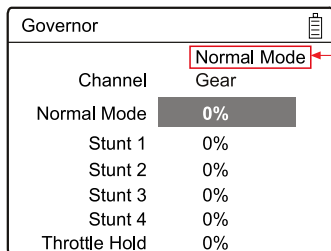

Display present flight mode

(1) Status

Toggle the Flight Mode or Throttle Hold switch, the status display present flight mode position. There are "Normal Mode", "Stunt 1", "Stunt 2", "Stunt 3", "Stunt 4", "Throttle Hold" and so on. "Throttle hold" need to start that can effect. (refer to "3.5 throttle hold")

(2) Channel: displaying in "2.10 output" have set the Channel. (refer to 2.10 Output)

(3) Normal Mode

Press "UP/DN" to make the navigation choose the "Normal Mode" set, press R/L to increase/decrease the value. The factory default value is 0%.

(4) The method to set "Stunt 1", "Stunt 2", "Stunt 3", "Stunt 4", "Throttle Hold" refer to "Normal Mode".

After the set finished, press EXT to exit.

3.10 Tail Curve

This function is mainly used for amending the reaction torque produced by pitch angle of main rotor blades. In the set flight mode, the mix amount can be automatically switched when moving the flight mode (FMOD) lever. Press ENT to enter the Main Menu; Press UP or DN to make the navigation mark to choose the Function Menu, then press ENT to the Functional Menu. Press UP or DN to choose "Tail Curve", then press ENT,

there will be shown an enquiry of "all Servo hold?" select ok for locking the current status of all the Servos, and cancel for unlocking the current status of all the Servos; After finish the choose, press ENT to "Tail Curve" interface. There are current flight mode status, and adjustable items.

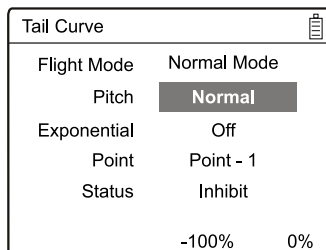
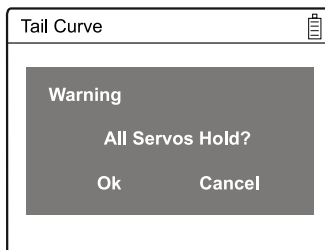

(1) Flight Mode

In the "Tail Curve" interface, press UP/DN to make the navigation mark choose "Flight Mode" set. Toggle the flight mode switch and shown the current flight mode. In the set of flight mode can set "pitch", "exponential curve", "curve point setting", and "output" items.

(2) Pitch

Press UP/DN to make the navigation mark choose "Pitch" set, press R/L to choose the two options Normal and Original. Select the desired item.

(3) Exponential Curve

Press UP/DN to make the navigation mark choose "Exponential" set, press R/L to choose two options On and Off. The curve will be smoothly changed if touching on. Select the desired item.

(4) Curve Point Setting: Press UP/DN to make the navigation mark choose "Point" set.

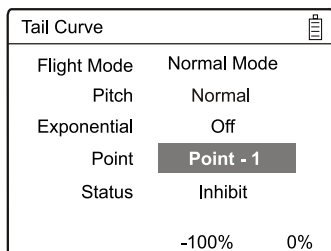

(4.1) Point Selection

Press R/L to set the Curve Point options "point-L", "point-one", "point-2", "point-M", "point-3", "point-4", "point-H", totally seven options; Select the point which you want to adjust.

(4.2) Statuses Setting

Press UP or DN option to choose the State setting after adjusting the date point. Press R or L keys, there are two options of "Inhibit" or "Active"(Choose "point-L" or "point -H", there is no state menu that will be shown).If you don't want to change the date,then choose "Inhibit"(default setting is "Inhibit"). If you want to change the date, then choose "Active", "Output" item will be expanded.

Tail Curve	
Flight Mode	Normal Mode
Pitch	Normal
Exponential	Off
Point	Point - 1
Status	Active
Output	0%
	-100% 0%

(4.3) Output Setting

Press UP/DN to make the navigation mark choose "output" set, press R to increase point's output; the minimum amount is +100%; press L to decrease point' output amount; the maximum amount is -100%.

(4.4) The methods to set "Stunt 1", "Stunt 2", "Stunt 3", "Stunt 4", "Throttle Hold" refer to "Normal Mode".after finished, press EXT to exit.

Notes: If an AVCS Gyro is used,this function is not necessary.

3.11 Dual Pitch

The " Dual pitch " should be activated in " Device output " if want to set this function. Seven-Point adjustment method is allowed to set up all the pitch curves respectively, in each flight mode, which includes Normal flight, Stunt 1, Stunt 2, Stunt 3, Stunt 4, Throttle Curve . "Throttle Curve should be activated if want to use (refer to "3.5 Throttle Curve " , "Stunt 3" , " Stunt 4" .The Flight Mode Extra Switch should be activated in " Device Select" , refer to 2.9 Device Select.

Press ENT to enter Main Menu, and then press UP or DN to move the navigational mark to select Function Menu.Press ENT to enter the Function Menu and then press UP or DN to select Dual Pitch and press ENT to enter the Dual Pitch interface which will show the setted output channel and the point.

Dual Pitch	
Channel	Gear
Point < L	Active 0%
Point - L	Active 0%
Point - 1	Inhibit

Press DN to select "Point< L "; Press R to increase point output values, the maximum is +100%, Press L to decrease point output values, the minimum is -100%.

Dual Pitch	
Channel	Gear
Point < L	Active 0%
Point - L	Active 0%
Point - 1	Inhibit

Press DN and then appear "Point-L", "Point-1", "Point-2", "Point-3", "Point-H", "Point>H". "Inhibit" and " Active" can be selected in the following: "Point-L", "Point-1", "Point-2", "Point-3", "Point-H". Press R or L to select "Active" if want to adjust, then press UP or DN to set the values, press R or L to adjust the values (the value is 0% if don't change), "±" (beside the values) means amend direction, the adjustable range is ±100%.

3.12 Swash Mix

This function, which can be executed through flight mode, is used for amending the variation caused by swashplate movement, when the aileron or elevator is working.

Press the ENT to enter Main Menu and then press UP or DN to choose the navigation mark of enter Function Menu. The interface will show the Swash Mix Setting after press the ENT. The "Swash Mix" item is only effected after choose the two or more servos in "2.11 Swash Type".Take the third servo 120° as an example.

Swash Mix	
	3 Servos 120°
Aileron	+60%
Elevator	+60%
Pitch	+60%
Exponential	Off

← Display of the present Swash Type

(1) Swash Type

The item will show the current swash type if choose the two or more servos in "2.11 Swash Type". the choosed swash type is the third servo 120° .

(2) Aileron Mix Adjustment

In the interface of Swash Mix,press UP or DN to choose the navigation mark of Aileron Setting item. Press R button to increase the rate and L to reduce. If reversed direction, it is available to chang through the "+" or "-" mark. The adjustable rate is $\pm 125\%$. After finish the settings, press DN to set others.

(3) Elevator mix adjustment

The function is based on the three or more servos which is choosed(refer to the 2.11 Swash Type).The setting method is same as above.

(4) Pitch Mix Adjustment

The function is based on the two or more servos which is choosed(refer to the 2.11 Swash Type).The setting method is same as above.

(5) Exponential Curve

This function can execute the exponential changes, which are set at Dual Rate and Exponential in Function Menu when it is started. If Off is selected, the exponential curve will be changed in the form of fold line.

Setting method:

Press UP or DN to touch the navigation mark of Exponential to expand two options: Off and On. the default setting is Off. On is recommended.

Please press EXT key to exit after finished.

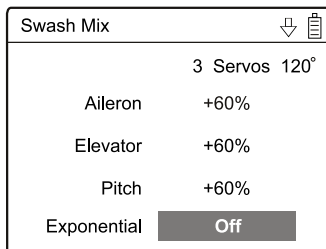

3.13 Pitch Curve

7-point adjustment method is allowed to set up all the pitch curves, respectively, in each flight mode, which includes Normal Mode, Stunt 1, Stunt 2, Stunt 3, Stunt 4, and Throttle Hold. The Flight Mode Extra Switch in Device Select should be previously chosen. Refer to "2.9 Device Select".

Setting method:

Press ENT to enter Main menu. Press UP or DN to move navigation mark to select Function Menu. Press ENT to enter function menu. Press UP or DN to select Pitch Curve. And press ENT to enter ENT to enter function menu. Press UP or DN to select Pitch Curve, press ENT to enter Pitch Curve interface, there is "All servos hold?", press ENT to confirm with OK for all the servos will be locked at the current states. Or use UP or DN to Cancel for Unlocked. Enter the next interface after confirmed OK or Cancel.

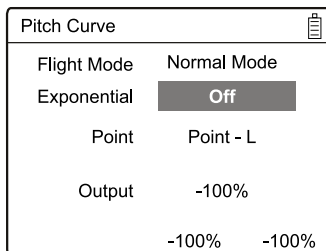
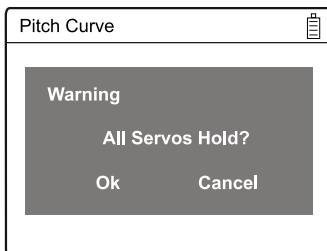

(1) Flight mode

Press UP or DN to select the Flight Mode at the interface of Pitch Curve, and then move the switch of flight mode, the state of flight mode will be shown. The Pitch Curve can be set at the current state. There are "Normal Mode", "Stunt 1", "Stunt 2", "Stunt 3", "Stunt 4" and "throttle hold" 6 flight modes.The "Normal Mode" is made as an example for your reference.

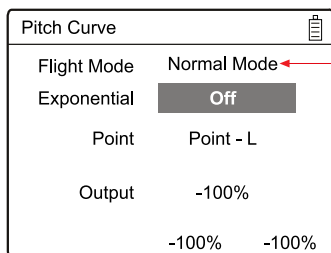

Display present flight mode

(2) Exponential

Press UP or DN to choose the setting item of Pitch Curve .There are ON or OFF option when you press the R or L buttons.The Curve Pitch will become round if the On button is choosen. If you don't adjust the Pitch Curve Funtion, then choose Off button.

(3) Setting of Curve Point

Press UP or DN to enter the setting interface of Curve Point. Press R or L keys of setting curve point, there are "point-L", "point -1", "point -2", "point -M", "point -3", "point -4", "point -H". Choose the points need adjusting.

(4) Status Setting

Press UP or DN option to choose the State setting after adjusting the date point. Press R or L keys, there are two options of "Inhibit" or "Active" (Choose "point-L" or "point -H", there is no status shown in the menu). If you don't want to change the date, then choose "Inhibit" (default setting is "Inhibit"). If you want to change the date, then choose "Active", "Output" and "Hovering" item will be expanded.

Pitch Curve	
Flight Mode	Normal Mode
Exponential	Off
Point	Point - 1
Status	Active
Output	-100%
Hovering	Off
	-100% -100%

(5) Output Setting

Press UP/DN to make the navigation mark choose "output" set, press R to increase point's output; the minimum amount is +100%; press L to decrease point's output amount; the maximum amount is -100%.

(6) Hovering Setting

When the above setup finished, the item Hovering should be set as On and each point of Pitch Curve should be activated at the same time if the PIT Trim needs to be adjusted in flight. The points of Point-1, Point-2, Point-M, Point-3, Point-4 will move at the same level with the up and down of the PIT when adjusting the Hovering Trim.

(7) There are "Normal Mode", "Stunt 1", "Stunt 2", "Stunt 3", "Stunt 4" and "Throttle hold" 4 flight modes. The PIT Curve can be set respectively at different models, the method of setting is as above. Press "EXT" key to exit after finished.

The basic examples are only for your reference. Adjustment to the real flights is a must.

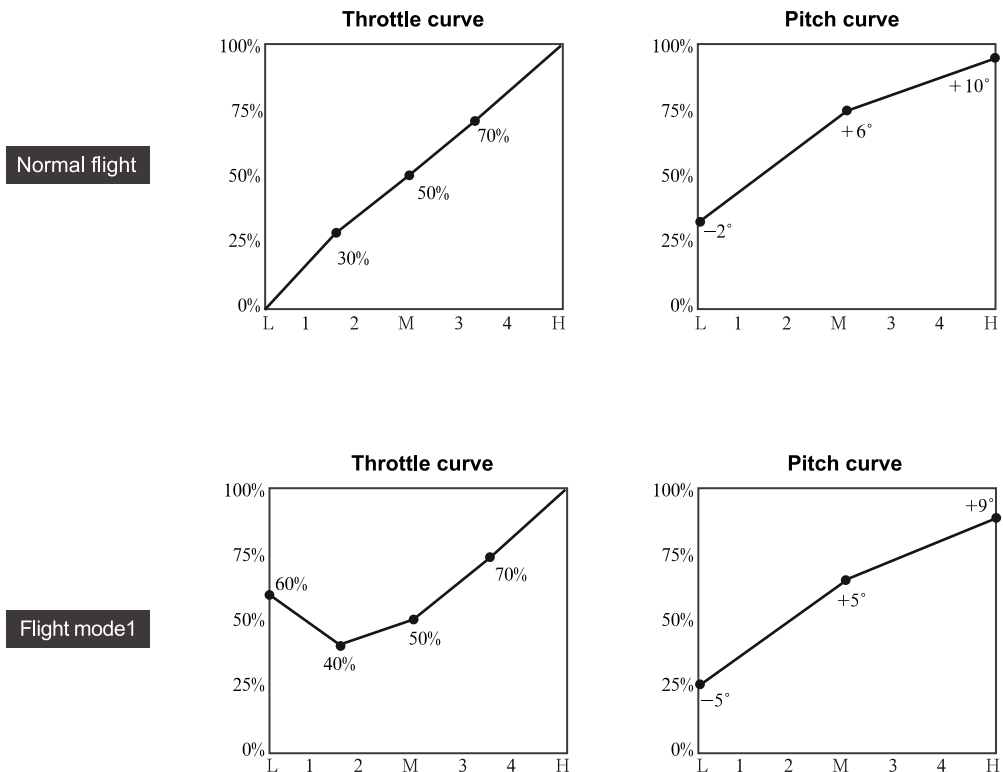

Flight mode 2

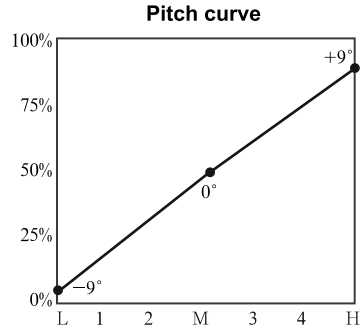
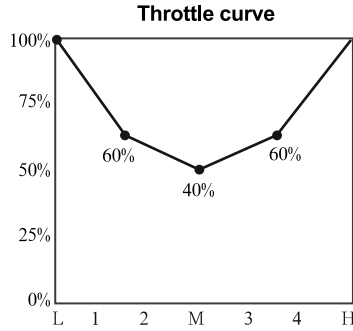

Autorotation landing

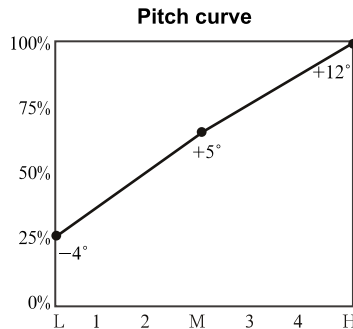

3.14 Program Mix

There are 8 series of program mix, mix channels and values are adjustable.

Setting Method:

Press ENT enter to Main Menu. Press UP or DN select function, press ENT to enter function menu, then press UP or DN select "Program Mix". And press ENT to Program Mix setting and current status (default setting is "Inhibit") interface. Press R or L to choose Inhibit, Normal or Curve.

Take "program mix 1" for example, there are "normal" and "curve" setting.

(1) The "normal" setting of "Program Mix 1"

Press UP or DN select the "Normal" setting, Press ENT button then pop up "All Servos Hold?" Press R or L to choose OK or Cancel. If "OK" selected, all the servos will be locked in the current status, if "Cancel" selected, all servos are unlocked. Press ENT enter to Program Mix 1 setting interface.

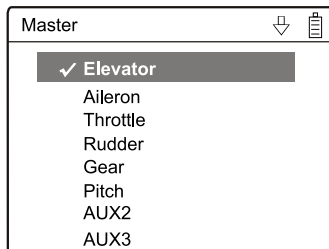
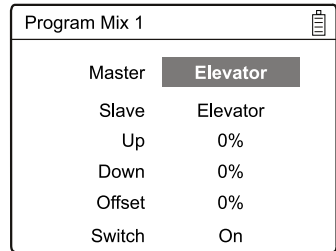
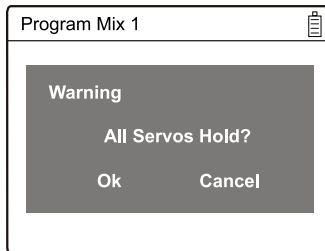
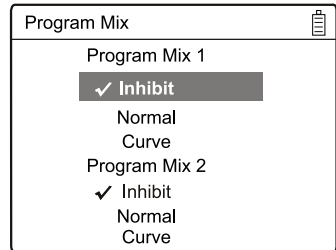

(1.1) Master channel setting

Press UP or DN to move the navigational mark to select Master option and press ENT to Master interface. Press UP or DN to select the desired channel and press ENT to make a "√". Press EXT to be back to Program Mix 1 interface.

(2) Slave channel setting

Press UP or DN to move the navigational mark to select Slave option and press ENT to Slave interface. Press UP or DN to select the desired channel and press ENT to make a “√”. Press EXT to be back to Program Mix1 interface.

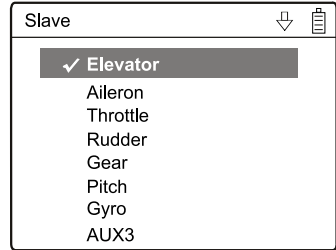

(1.3) Gain setting: Take Elevator at Master as an example.

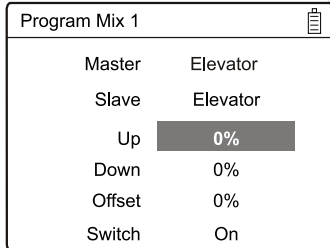

(1.3.1) UP:

Mix amount setting when elevator stick moved upward.

Press UP or DN to move the navigational mark to select Up to item. Press R or L to increase or decrease, separately, the mix amount. It is possible to reverse mix direction through changing the plus or minus sign before amount. The adjustable range is ±125%.

(1.3.2) Down:

Mix amount setting when elevator stick moved backward. Press UP or DN to move the navigational mark to select Down item. Press R or L to increase or decrease, separately, the mix amount. It is possible to reverse mix direction through changing the plus or minus sign before amount. The adjustable range is ±125%.

(1.3.3) Offset Setting

This function can make Slave begin to mix through the corresponding Lever switch from a certain point as the starting point.

Press UP or DN select the “Offset” setting, Press R to increase the mix amount and press L to decrease. It is possible to reverse Offset direction by pressing R or L button to change the plus or minus sign before amount. The adjustable range is ±100%.

(1.4) Switch Selection

Press UP or DN to choose the navigation mark of Switch setting item and press ENT to enter the select interface of Switch. It is chosen if the Switch item is marked with “√”. After finished, press EXT to return to the Program Mix to make other settings or press EXT once again to exit.

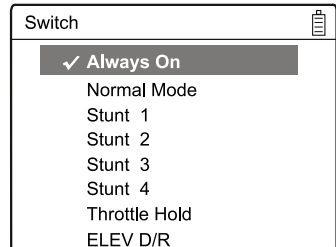
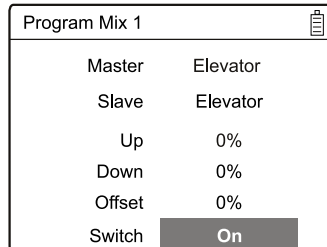

(2) Setting Method for Curve in Program Mix1

Press UP or DN to select Curve, press ENT to confirm. Then the interface pop up "All Servos Hold?", press R or L to choose OK or Cancel. If select OK, all the servos will be locked in the current status, if select Cancel, all servos are unlocked. Press ENT to setting interface of program Mix1.

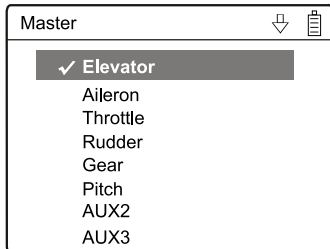
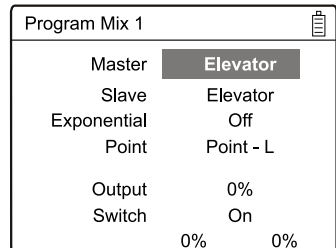
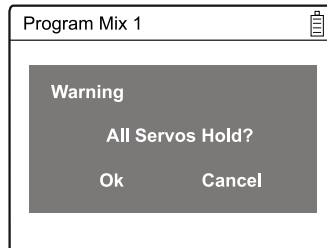

(2.1) Master channel setting

Press UP or DN to move the navigational mark to select Master option and press ENT to Master interface. Press UP or DN to select the desired channel and press ENT to make a “√”. Press EXT to be back to Program Mix 1 interface.

(2.2) Slave channel setting

Press UP or DN to move the navigational mark to select Slave option and press ENT to Slave interface. Press UP or DN to select the desired channel and press ENT to make a "✓". Press EXT to be back to Program Mix1 interface.

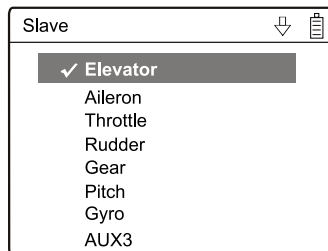

(2.3) Exponential Curve

Press UP or DN to choose the setting item of "Exponential". There are On or Off option when you press the R or L buttons. Select On for smooth changes, and Off for changes in the form of fold ling in Exponential curve, respectively.

(2.4) Point Setting

Press UP or DN to move the navigation mark of Point option. Press R or L, there are 7 piont options including "Point-L", "Point-1", "Point-2", "Point-M", "Point-3", "Point -4" and "Point-H". Select the point you want to set.

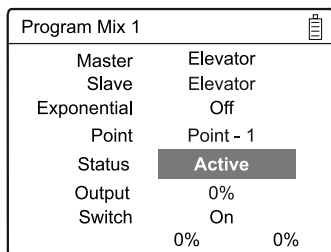
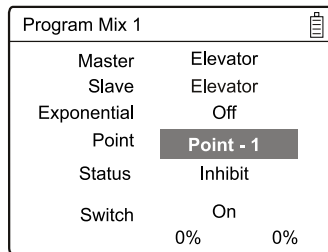

(2.5) Status Setting

(There is no Status options when the piont is Point-L or Point-H) After selecting the point that you want to set, press UP or DN to move the navigational mark to Status item. Press R or L, there are two options of Inhibit and Active. Select Inhibit for unchanging the current amount (the default setting is Inhibit).

(2.6) output setting

When the Status option is Active, the Output option will be listed. Press UP or DN to move the navigational mark to Output. Press R or L to increase or decrease, respectively, the output amount. It is possible to reverse the mix direction by changing the plus or minus sign before the amount. The adjustable range is ±100%.

(2.7) Switch Selection

Press UP or DN to choose the navigation mark of Switch setting item and press ENT to enter the select interface of Switch. It is chosen if the Switch item is marked with "✓". After finished, press EXT to return to the Program Mix to make other settings or press EXT once again to exit.

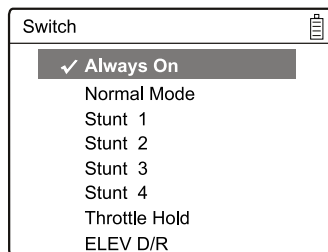
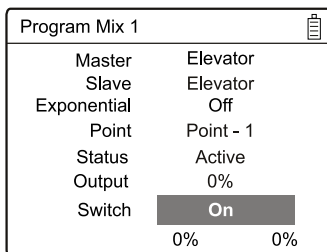

3.15 Monitor

This function can display the current status and positions of all the channels' outputs, and check the current working status of each channel.

Press ENT to enter Main Menu, and then press UP or DN to move the navigational mark to select Function Menu. Press ENT to enter the Function Menu and then press UP or DN to select servo Monitor and press ENT to enter the monitor interface for checking the current working status of each channel.

Press EXT to exit .

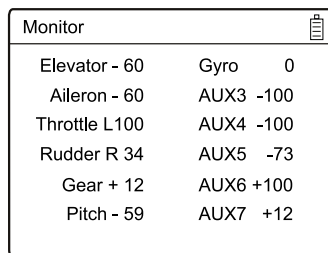

3.16 Fail safe

There are two possibilities for use if the transmission signal is under abnormal condition. The first one is to lock the last action data received; the second one is to execute the pre-set data which is pre-set. The default setting is Servo Hold.

Setting method:

Press ENT to enter the Main Menu, and then press UP or DN to move the navigational mark to select Function Menu. Press ENT to enter the Function Menu then press UP or DN to select Fail Safe and press ENT to enter the Fail Safe interface. Take the item Elevator as an example to explain.

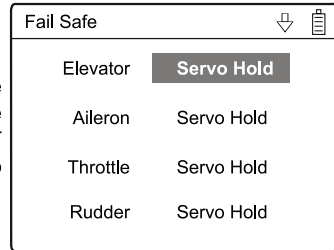

Press UP or DN to select Elevator on the Fail Safe interface, then press R or L to change the status of Servo Hold into Fail Safe (If you want to keep Servo hold status, there is no need to re-set). There is an expanded sub-item blow. Press UP or DN to select 0%, then press R or L to increase or decrease, respectively, the position amount which centers on the neutral point of servo. The available value is 125%, respectively. 0% is the neutral point of servo.

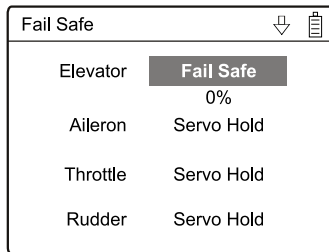

The setting methods for other channels are same as above. Press EXT to exit after finished.

Note: checking whether all the actions when fail safe happened are correct, is a must after the setting is finished. It is dangerous to use full throttle, especially after fail safe taken place.

3.17 Sensor View

Setting method: Press ENT to enter the Main Menu and press UP or DN to move the navigational mark to select Function Menu. Then press ENT to enter the Function Menu and press UP or DN to select Sensor View, then press ENT to enter the Sensor View interface, like below pictures. If all the sensors disconnect, telemetry signal lost, there will be inhibits shown on the view. If all work normal, all the measured data will be shown.

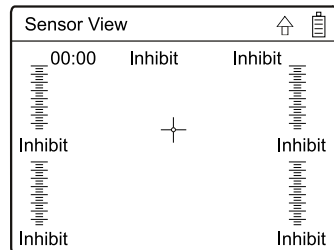
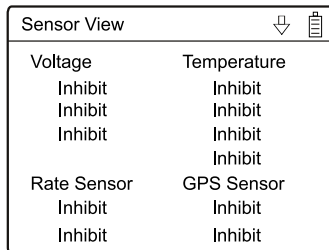

- (1) Voltage: Show 3 different measured voltage value;
- (2) Temperature: Show 4 different measured temperature value;
- (3) Rate Sensor: Show 2 different measured RPM value;
- (4) GPS image display: in the interface of Sensor View, press DN to go to GPS image display. It will show: local time, longitude, latitude, altitude, move speed, and battery Volume. If you set the image as the background, these informations will be seen from the image.

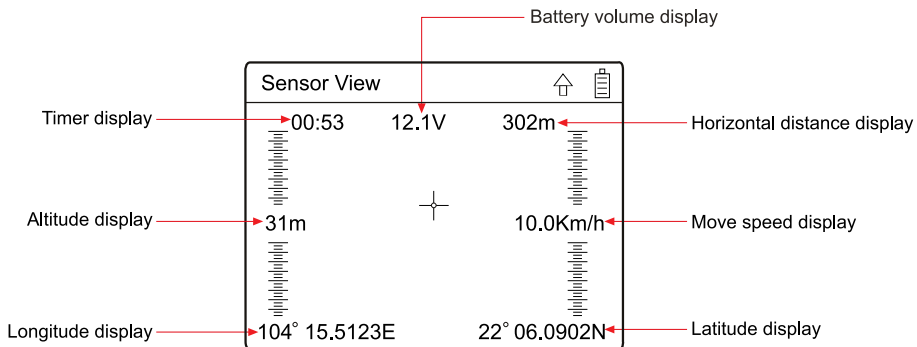
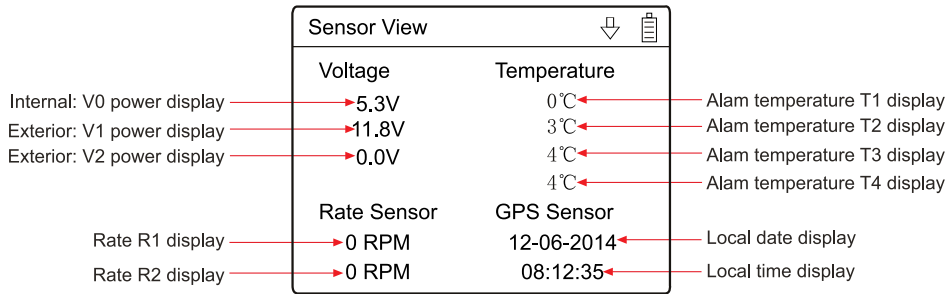

3.18 Trainer

Two DEVO F12E transmitters working together can execute the training function to meet the requirements for the beginner. The setting method is shown as below:

(1) Data copy

First, use the wireless copy function between two DEVO F12E to copy the main transmitter's model data to the trainee's transmitter, this promise the model data between two transmitters is same. Refer the copy method to the second part of helicopter "2.4 model wireless copy" and do the following steps:

(2) Linkage

Insert the digital signal wire from the trainer's transmitter into the DSC socket of the trainee's transmitter. Turn on the transmitter and a linkage icon will be shown on the boot screen.

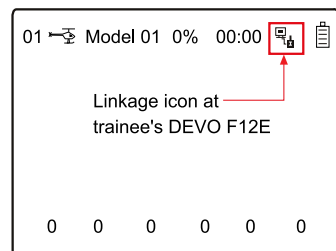

linkage icon

Turn on the power of the trainer's radio. Find out the trainee's model data, and then let the trainer's Radio bind with the aircraft model and fly it normally. Then turn off the power. Insert the other end of the digital signal wire into the trainer's DEVO F12E, and then turn on its power. A linkage icon will be shown as below:



Trainer icon

Training status display: when the trainer's icon becomes into "X", the trainee stops flying and the trainer is working; when the trainer's icon turns into "✓", the trainee is flying and the trainer is in leisure.

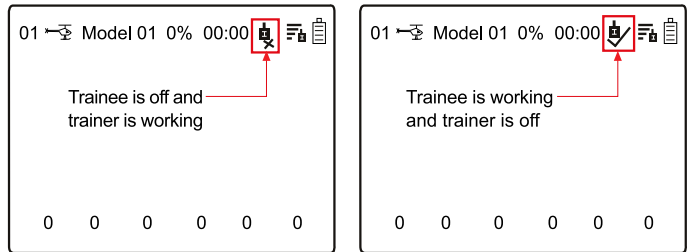

(3) Usage method

The training switch can be freely switchable between left trim and right trim. The default setting is right trim, see as the right illustration.

During flight, if the trainer pushes Right Trim once, the linkage icon will be shown as "✓" that means the control right is moved to the trainee from Trainer. If trainer pushes Right Trim once again, the linkage icon will be shown as "X" that means the trainer takes back the control right from the trainee.

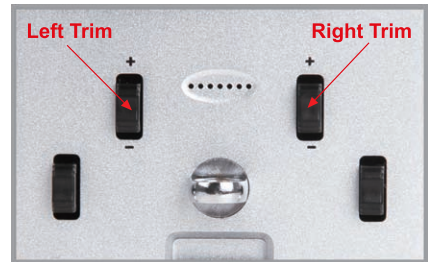

(4) Setting for training function channels

Trainee is available to get full or part of flight control power to the aircraft model via setting the training function channel in the trainer's radio. Below is the setting method:

Press the ENT to enter Main Menu, and then press UP or DN to move the navigational mark to select Function Menu. Then press ENT to enter the Function Menu and press UP or DN to select "Trainer", then press ENT to enter the Trainer interface. The available channels are shown below, and the current status of trainer switch is also shown there.

Trainer		↓	☰
Switch	Right Trim		
Elevator	Inhibit		
Aileron	Inhibit		
Throttle	Inhibit		
Rudder	Inhibit		
Gear	Inhibit		
Pitch	Inhibit		
Gyro	Inhibit		

Trainer switch selection: Press UP or DN to select the switch option; press R or L to select the switch which you want. It includes right and left trim. The default setting is Right trim.

Channel selection: Press UP or DN to select the channel option; Press R or L to select the channel(s) which you want to grant to trainee. The channel(s) you have selected will be activated as "Active". The channels which are not granted to trainee will be kept inhibited. The default setting is "Inhibit".

Press EXT to exit.

3.19 Timer

There are two timers which can be set as stopwatch and countdown, respectively. Each timer can be operated by switch or by shortcut.

Setting method:

Press ENT to enter Main Menu, and then press UP or DN to move the navigational mark to select Function Menu. Then press ENT to enter the Function Menu and press UP or DN to select "Timer", then press ENT to enter Timer interface. The timing range of stopwatch is from 00:00 to 59:59 (59 minutes 59 seconds).The default setting is stopwatch.

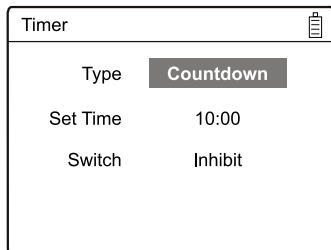
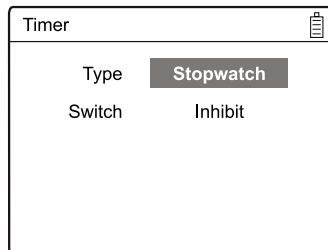

(1) Countdown setting

If you need countdown time manner, press R or L to select the countdown. There is an expand sub-menu set time item. Press UP or DN to move the navigational mark to select the option of Setting time item. Press R or L to set the countdown time. The settable countdown time range is from 00:10 to 59:50.

(2) Switch selection

Press UP or DN to move the navigational mark to Switch. There are Inhibit and available switch options, available switch can be selected by press L or R. It includes FMOD1,2, FMOD2, MIX1,2, MIX2, ELEV D/R, AILE D/R, RUDD D/R, GEAR SW, SPS0 SW, SPS1 SW, SPS2 SW and SPS3 SW. We can select the desired item except these items of SPS0 SW, SPS1 SW, SPS2, and SPS3 which should be previously set at Stick Position Switch at Model Menu (refer to "2.8 Stick Position Switch").

Press EXT to exit after finished.

(3) Usage of timer

Press UP or DN in main panel. It's possible to start Timers by pressing UP key for one time, and to pause it by pressing it the second time. Press DN to clear timer. It's ok to control time by Switch when time setting is finished on switch. Timer will be shown in main interface, as right illustration:

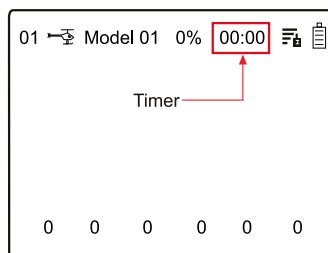

devention

DEVO F12E

Part three Airplane

All the functional settings, which are relative to the operation system of DEVO F12E itself, are fully integrated in System Menu. They include Language, Display, Buzzer, vibrator, Video Setting, Stick Mode, Stick Direction, Stick calibration, Battery and About.

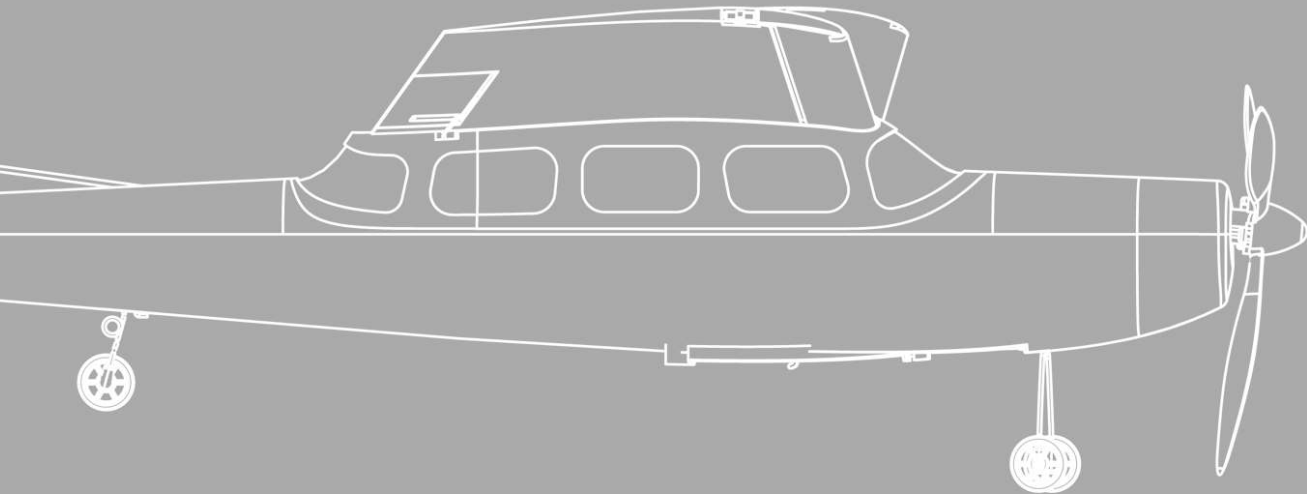

1.0 System Menu

All the functional settings, which are relative to the operation system of DEVO F12E itself, are fully integrated in System Menu. They include Language, Display, Buzzer, Vibrator, Video Setting, Stick Mode, Stick Direction, Stick calibration, Battery and About.

Below is the boot screen of Airplane (e.g. throttle stick on the right):

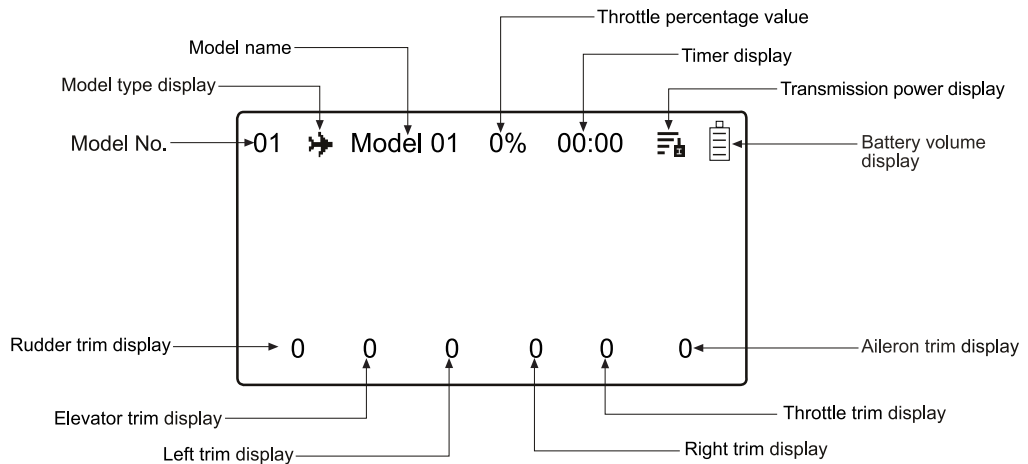

1.1 Language setting

Press ENT to the Main Menu, press UP or DN to select System Menu, then press ENT to System Menu.

Press UP or DN to select "Language" and press ENT to the Language setting interface. Press UP or DN to select the language that you want. A "✓" will be shown on the screen after selected. Press EXT to exit.

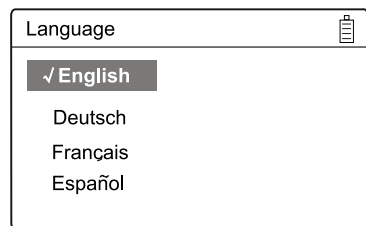

1.2 Display

Press ENT to the Main Menu, press UP or DN to select System Menu, then press ENT to System Menu. Press UP or DN to select "Display" and press ENT to the Display setting interface. Press UP or DN to select the needed setting and press R or L set.

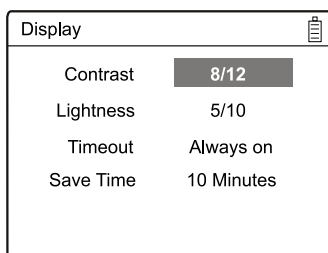

Three items are available to be set. Below are the setting methods for them:

- (1) Backlight contrast: the backlight contrast is adjustable by pushing UP or DN to move the navigational mark to the digits after Contrast. Press R key to increase the backlight contrast, while press L to decrease it.
- (2) Backlight lightness: the backlight lightness is adjustable by pressing UP or DN to move the navigational mark the digits after Lightness. The power consumption will be increased if the backlight lightness is too bright and the battery cruise duration will be shortened. Press R or L to increase or decrease the lightness. When the value is one means turn off the backlight.
- (3) Backlight timeout: it is possible to set the duration which LCD stays at highlight in the form of "Always on" or any period from 5 to 60 seconds with an interval of 5 seconds. Press UP or DN to move the navigational mark to select the digits after Timeout. Press L to short the time of backlight duration or keep it in the form of "Always on" while push R or prolong the time. The maximum is 60s.

(4) Save Time: the Save time setting can set extinguish time when there is no operation on screen, can save the power, and extend the using time of the battery, can also set as always lighting.

Press UP or DN to select the number behind the Save time, Press R can make the always lighting longer, the longest time is 30mins; Press L can reduce the always lighting time or always open. Press EXT to exit.

1.3 Buzzer warning

Press ENT to the Main Menu, press UP or DN to select System Menu, then press ENT to System Menu. Press UP or DN to select "Buzzer" and press ENT to the Buzzer setting interface. Press UP or DN to select the needed setting and press R or L set.

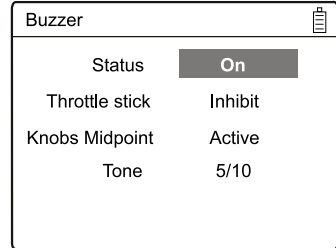

- (1) Status: there are On and off two status on the Buzzer interface. Pressing UP or DN to move the navigational mark to the status option. Pressing R or L to change the On or Off status. It includes Throttle stick, knobs Midpoint and Tones items under the status is On.
- (2) Throttle stick buzzer: Press UP or DN to move the navigational mark to Throttle Stick item then press R or L to change the status from Inhibit to Active. When Buzzer is at the status of On, if Throttle Stick is set as "Active", there is buzzer sound when you push the throttle stick to the midpoint. If you don't need the buzzer sound, please change the status to Inhibit.
- (3) Knobs midpoint Buzzer: When Buzzer is at the status of On, if Knobs is set as "Active", there is buzzer sound when you turn the AUX4 and AUX5 to the midpoint. If you don't need the buzzer sound, please change the status to Inhibit.
- (4) Buzzer tone: the tone is composed of 10 grades. You can choose the favorite one according to your interests. Press UP or DN to move the navigational mark to Tone item and press R or L to make a listening test. Press EXT to exit.

1.4 Vibrator

The vibrator used as an alarm function to remind the users.

Press ENT to get the Main Menu, press UP or DN to select System Menu. And then press ENT to get System Menu, press UP or DN to select Vibrator. Press ENT to get Vibrator setting interface. There are two status as Inhibit and Active. Press R or L to select Active if need. Press EXT to exit after finished.

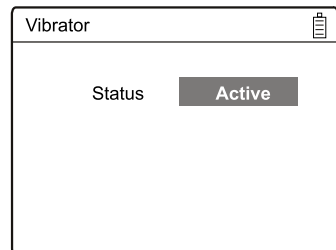
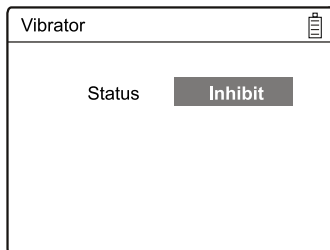

1.5 Video Setting

Press ENT to get the Main Menu, press UP or DN to select System Menu. And then press ENT to get System Menu, press UP or DN to select Video Setting. Press ENT to get Video setting interface. Press R or L to select Inhibit or Active.

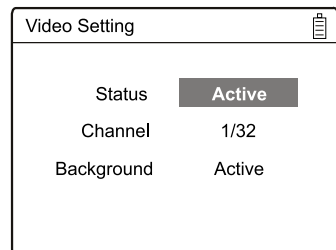
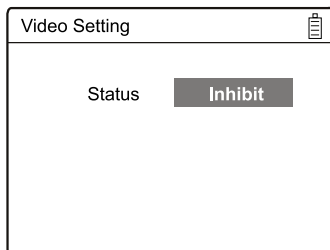

- 1) Status Selection: choose Inhibit to inhibit video show; choose Active to active video show and the interface will extend 32 channels for selection.
- 2) Channel Selection: choose the corresponding channel of 5.8G transmitter module then the background will show the image which it receives.
- (3) Background: there are two selections Inhibit and Active. Choose Active to show the image in the main interface as the background. Press EXT to return main interface after having finished the settings. In the main interface, press EXT to enjoy the full screen display.

1.6 Stick Mode

Press ENT to get Main Menu, press UP or DN to select System Menu, and then press ENT to the System Menu, press UP or DN to select Stick Mode, and press ENT to get stick mode setting interface.

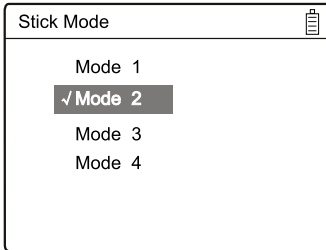

MODE 2 and MODE 4 are listed in left-hand throttle.

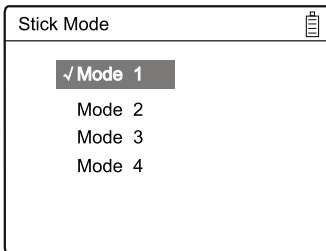
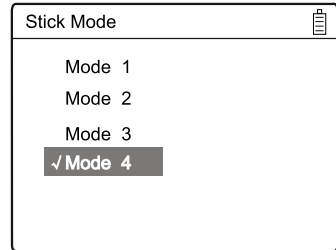

MODE 1 and MODE3 are listed in right-hand throttle.

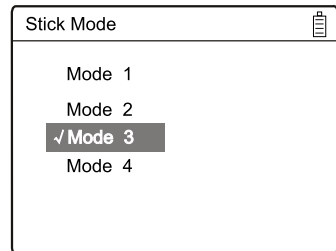

Select the stick mode according to the throttle mode showing on the screen. DEVO F12E offers 4 stick modes, please refer to "8.0 Switches exchange between left-hand and right-hand throttles. Press EXT to exit after finished.

1.7 Stick Direction

Press ENT to get Main Menu, press UP or DN to select System Menu, and then press ENT to the System Menu, press UP or DN to select Stick Direction, and press ENT to get stick direction setting interface.

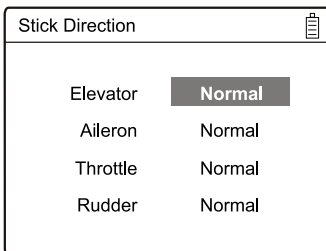

Stick Direction: There are four items available as Elevator, Aileron, Throttle and Rudder. Press UP or DN to select the stick which will change direction, and press R or L to change the direction. The factory setting is Normal.

1.8 Stick Calibration

It is a function to re-calibration when stick unusual.

Calibration method:

Press "ENT" to the Main Menu, press UP or DN to select System Menu, then press ENT to System Menu. Press UP or DN to select Stick Calibration and press ENT to the Stick Calibration setting interface.

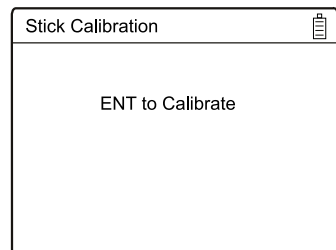

Press ENT button to enter the calibration, Repeat to shark the left and right of the remote control sticks from the rock bottom to highest respectively for several times and then back to the rocker. Press ENT to confirm , if your action is wrong, will display "please Retry!" ; If correct, display "calibration success!" . And then press EXT exit.

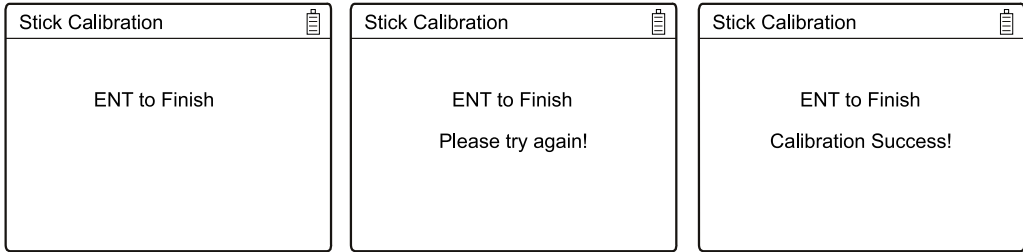

1.9 Battery

Battery voltage can set up the warning value for radio battery in lower voltage.

Press ENT to the Main Menu, press UP or DN to select System Menu, then press ENT to System Menu. Press UP or DN to select "Battery" and press ENT to the Battery setting interface. Warning voltage value can be changeable by R or L button.

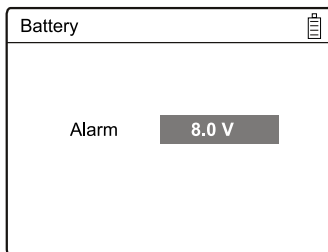

Low Voltage Warning: Please set up the low voltage warning value when you turn it on following the battery specification.

Battery voltage	Li-Po battery 7.4V	Li-Po battery 11.1V	Dry battery 8x1.5V
Advised warning voltage	6.4V	9.6V	8.0V

1.10 About

Press "ENT" to the Main Menu, press UP or DN to select System Menu, then press ENT to System Menu. Press UP or DN to select About and press ENT to the About setting interface.

Press EXT to exit after finished.

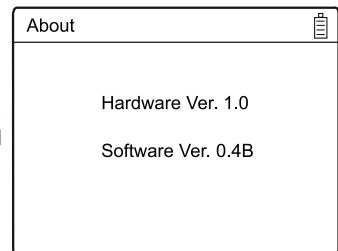

2.0 Model Menu

Model Menu manages all the model data saved in DEVO F12E. It includes Model Select, Model Name, Model Copy, Model Transmit, Model Receive, Model Reset, Type Select, Trim System, Stick Position Switch, Device Select, Device Output, Wing Type, Power Amplifier, Fixed ID and Sensor setting.

2.1 Model Select

Press ENT to enter Main Menu and press UP or DN to make Model Menu is selected. Press ENT to get the Model Menu and press UP or DN to select Model select, press ENT to enter the Model Select setting interface.

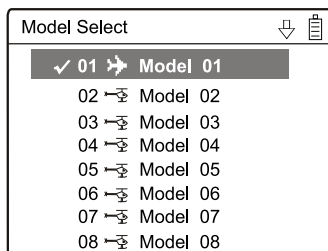

Press UP or DN to select the model you desired, press ENT to confirm and marks "✓" in the front of selected one. Total 15 models are optional, used to save the model data. Press EXT to exit after finished.

2.2 Model Name

In the menu of model name, you can make a desired name for your model for long term storage. Its data can be directly withdrawn in next flights. Repeat the step "2.1 Model Select" to choose the model you want to name or save, press EXT to back to the interface.

Press "ENT" to enter Main Menu, press UP or DN to select "MODEL Menu", then Press "ENT" to enter Model Menu; Press UP or DN to select "Model NAME" and then press "ENT" button to enter the "Model Name" setting interface.

Press UP or DN to select the character and figure which are needed to be changed, press R or L button to change the character and figure, and press UP or DN to set next one. Press EXT to exit after finished.

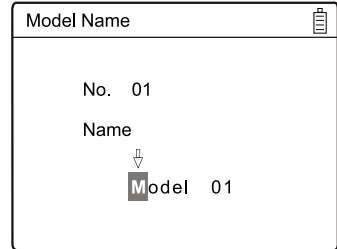

2.3 Model Copy

Press ENT to enter "Main Menu" and press UP or DN to make "Model Menu" is selected. Press ENT to enter "Model Menu" and press UP or DN to select "Model Copy", press ENT to the "Model Copy" setting interface as picture (1).

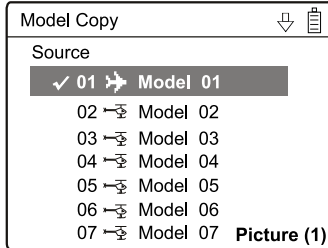

Press UP or DN to choose the source of model copy, press ENT to confirm then you can see the Destination selection as picture (2).

Press UP or DN to choose the destination of model copy, press ENT to confirm then you can see the ask interface as picture (3). Press ENT to execute the operation and return to model menu. Press EXT to exit if not need to execute the operation.

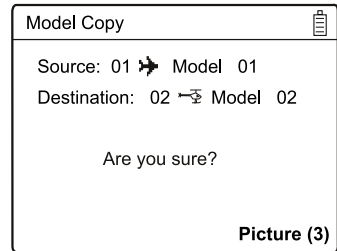
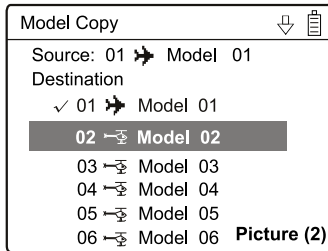

2.4 Model wireless copy

The model data between two DEVO F12E equipments can be wirelessly copied via Model Transmit and Model Receive in Model Menu.

(1) Model transmission

Press ENT to enter "Main Menu" and press UP or DN to select "Model Menu". Press ENT to enter "Model Menu" and press UP or DN to select "Model transmission", continue to press ENT to enter "Model Transmit" setting interface.

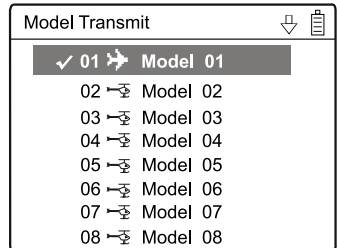
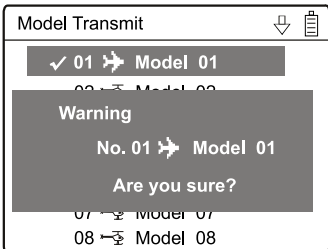

Press UP or DN to choose the source model which will be transmitted, and press ENT to confirm, an enquiry information "Are you sure?" will be shown as left Illustration.

Press ENT to transmit, “Transmitting” appears in the interface. Or press EXT to exit. Press EXT to exit after another DEVO F12E received the data.

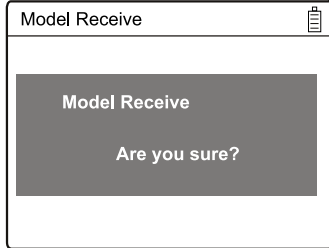
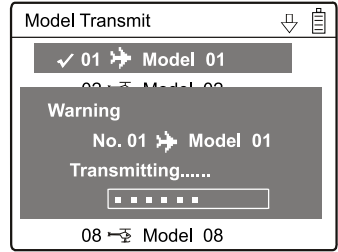

(2) Model receiving

Press ENT to enter Main Menu and press UP or DN to select Model Menu. Press ENT to get Model Menu and press UP or DN to select Model Receiving, continue to press ENT to enter Model Receive setting interface. An enquiry information “Are you sure?” will be shown as left Illustration.

Press ENT to receive, “Connecting” and “Receiving” will be shown in series in the interface. The information of “Received” with the model name will be shown after receiving is finished. Or press EXT to exit.

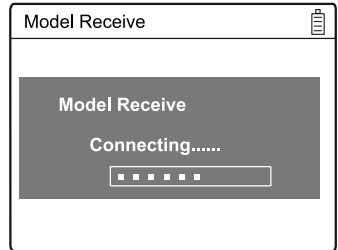

Press UP or DN to choose the save position, an enquiry information “Are you sure?” is shown after press ENT. Press ENT to save or press EXT to exit.

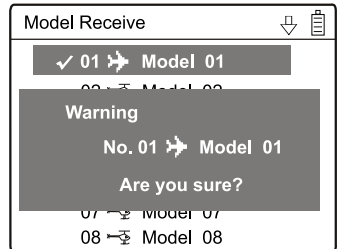
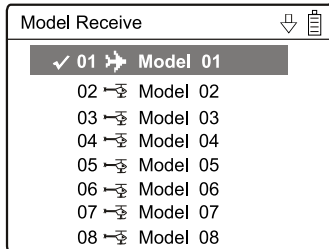

2.5 Model reset

All the model data can be restored to factory settings via Model Reset.

Press the ENT to enter Main Menu and press UP or DN to select Model Menu. Press ENT to get Model Menu and press UP or DN to select Model Reset, press ENT to enter Model Reset setting interface.

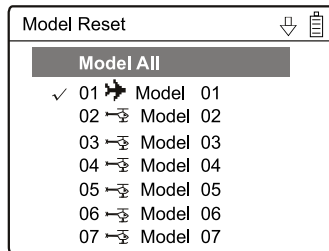

It is possible to store up to 15 models data in the model list of DEVO F12E equipment. There are two methods to reset the model data: batch reset and single reset.

Batch reset: press UP or DN to select Mode All, an enquiry information “are you sure?” will be appears in the interface. Press ENT to reset all models, or press EXT to exit.

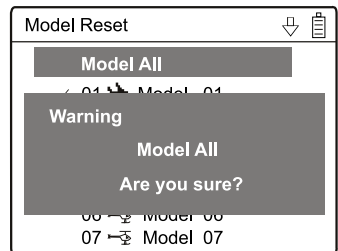

Single reset: Press UP or DN to choose the model you want to restore, “Are you sure?” will appear after press ENT. Press ENT to reset or press EXT to exit.

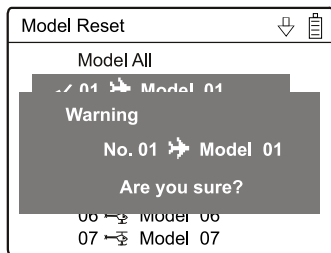

2.6 Type Select

This device offers three model types menu. They are Helicopter, Airplane and Glider respectively.

Press ENT to enter Main Menu and press UP or DN to select Model Menu. Press ENT to enter and press UP or DN to select Type Select and press ENT to enter setting interface.

Press “ENT” button to get Helicopter, Airplane and Glider selections and press UP or DN to select and press ENT to confirm, then press EXT to exit.

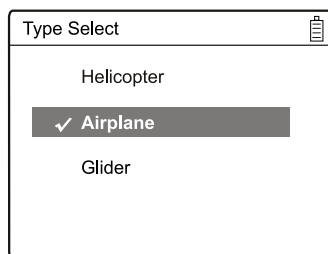

2.7 Trim System

Trim System is able to finely tune the following six items, respectively: Elevator, Aileron, Rudder, Throttle, Left Trim and Right Trim. The trim range is divided into 20 grades (factory default is set at 4). It is convenient to subtly modify the pitch by adjusting the trim range.

Press ENT to enter Main Menu and press UP or DN to select Model Menu. Press ENT to enter and press UP or DN to select Trim System, press ENT to enter Trim System setting interface. Press UP or DN to select the trim which will set, press R to increase the trim value and press L to decrease.

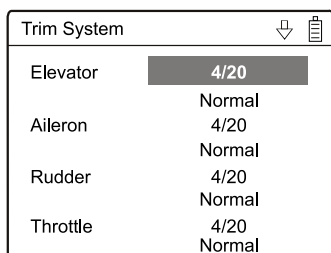

For elevator, aileron, and rudder, there are two more options: Normal and Limited, press R or L you can change the setup. “Normal” means the trim is always working although the corresponding stick stays anywhere. “Limited” means the trim is out of working when the corresponding stick is at maximum position.

Press EXT to exit after finished.

2.8 Stick Position Switch

According to the following setting, the switch can be used as a switch. The turn-on or turn-off position at which stick stays can also be settable.

Method for setting:

Press the ENT to enter Main Menu and press UP or DN to select Model Menu. Press ENT to get Model Menu and press UP or DN to select Stick Position Switch, press ENT to enter Stick Position Switch setting interface.

There are four options under the Stick position switch: SPS0, SPS1, SPS2, SPS3. Press R or L to choose the switch you want to define.

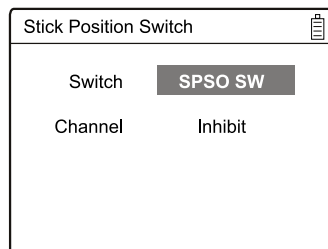

Press UP or DN to inhibit channel in navigation mark, and press R to expand the menu. The channel includes four items: Elevator, Aileron, Throttle and Rudder. The factory default is Inhibit. Take Elevator for example.

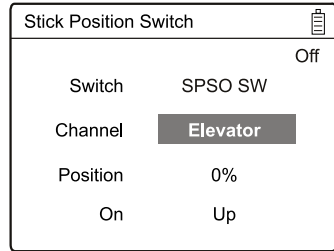
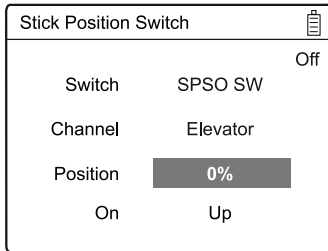

Press R or L to choose the Elevator as stick, then Press UP or DN to move navigation mark to value of position. It's possible to adjust the stick position via pressing R or L.

Press UP or DN to navigate the On setting, press R or L to change the direction of the channel stick.

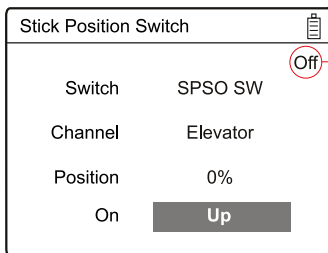

Display of stick position switch status

Moving the stick to make sure that the direction of stick's turn-on or turn-off position is correct.

After finished the setting, press EXT to exit.

2.9 Device select

This setting can help you configure various functional switches, or adjust levers. It includes Flight Main Switch, Flight Extra Switch, Flight Mode Trim, Throttle Hold Switch, Flap Switch, Flap Trim.

Press ENT to enter Main Menu, press UP or DN to move navigation mark to select Model menu. Press ENT to enter Model menu. Press UP or DN to Device select Option. Press ENT to Device select Option interface.

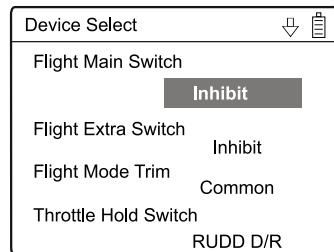

(1) Flight Main Switch:

Press UP or DN to move navigation mark to Flight Main Switch and press R or L to select the desired switch. The factory default setting is FMOD switch.

(2) Flight Extra Switch:

Press UP or DN to move navigation mark to Flight Extra Switch and press R or L to select the desired switch. The factory default setting is Inhibit.

(3) Flight Mode Trim

There are two modes: Common and Flight Mode. In Common option, the adjustment parameter, of which the stick is corresponding to trim, puts an equal effect on all the flight modes.

In Flight Mode, the adjustment parameter, of which the stick is corresponding to trim, puts a respective effect on the corresponding flight mode. The factory default setting is Common.

Press UP or DN to move navigational mark to Flight Mode Trim, press R or L to select Common or Flight Mode. The factory default is Common.

(4) Throttle Hold Switch: Refer to (1) Flight Main Switch.

(5) Flap Switch: Refer to (1) Flight Mode Switch.

(6) Flap Trim: Refer to (1) Flight Mode Switch.

After finishing the setting, press EXT to exit.

2.10 Device Output

Device output can set up the output switches respectively. It can also activate, inhibit or use other functions. There are eight items in total: FMOD switch, MIX switch, ELEV D/R switch, AILE D/R switch, RUDD D/R switch, GEAR switch, SPSO, SPS1, SPS2, SPS3, left trim, right trim, AUX4 KB, AUX5 KB, AUX6 KB, AUX7 KB.

Setting:

Press ENT to enter Main Menu, press UP or DN to move navigational mark to Model Menu. Press ENT to enter Model menu. Press UP or DN to select "Device Output" and press ENT to enter "Device Output" interface.

Below eight items can be adjusted: Gear, Flap, AUX2, AUX3, AXU4, AUX5, AUX6, AUX7.

(1) Gear

Press UP or DN in output interface can change the gear switch. It includes FMOD SW, MIX SW, ELEV D/R, AILE D/R, RUDD D/R, GEAR SW, SPSO SW, SPS1 SW, SPS2 SW, SPS3 SW, Left Trim, Right Trim, AUX4 KB, AUX5 KB, AUX6 KB, AUX7 KB. Press R or L to select the setting switch, The default setting is GEAR SW.

Device Output	
Gear	GEAR SW
	Active
Flap	System
	System
AUX2	FMOD SW
	Gyro
AUX3	RUDD D/R
	Active

Device Output	
Gear	GEAR SW
	Active
Flap	System
	System
AUX2	FMOD SW
	Gyro
AUX3	RUDD D/R
	Active

Press UP or DN to select Function Setting after you select the switch, Press R or L enter the interface of Gear Inhibit, Active, Gyro, Governor and Pitch. The default setting is Active. You can continue to set other items after finishing.

(2) Flap

Press UP or DN to move navigational mark to function setting below Flap. Press R or L to choose the item, there are three selectable items: Inhibit, Active, System. The factory default setting is System. If you want to set yourself, press R to set flap output.

Device Output	
Gear	GEAR SW
	Active
Flap	System
	System
AUX2	FMOD SW
	Gyro
AUX3	RUDD D/R
	Active

Device Output	
Gear	GEAR SW
	Active
Flap	MIX SW
	Active
AUX2	FMOD SW
	Gyro
AUX3	RUDD D/R
	Active

Device Output	
Gear	GEAR SW
	Active
Flap	MIX SW
	Active
AUX2	FMOD SW
	Gyro
AUX3	RUDD D/R
	Active

Press UP or DN to move navigational mark to Flap. Press R or L to expand the menu including FMOD SW, MIX SW, ELEV D/R, AILE D/R, RUDD D/R, GEAR SW, SPSO SW, SPS1 SW, SPS2 SW, SPS3 SW, Left Trim, Right Trim, AUX4 KB, AUX5 KB, AUX6 KB, AUX7 KB. The default setting is MIX SW.

(3) AUX 2

Press UP or DN to enter the AUX2 interface. Press R or L can change the AUX2 switch. It includes FMOD SW, MIX SW, ELEV D/R, AILE D/R, RUDD D/R, GEAR SW, SPSO SW, SPS1 SW, SPS2 SW, SPS3 SW, Left Trim, Right Trim, AUX4 KB, AUX5 KB, AUX6 KB, AUX7 KB. The default setting is FMOD SW.

Press UP or DN to select the Function setting, press R or L to choose the switch, it includes inhibit, Active, Gyro, Governor, Pitch. The default setting is Gyro. You can continue to set other items after finished .

Device Output	
Gear	GEAR SW
	Active
Flap	System
	System
AUX2	FMOD SW
	Gyro
AUX3	RUDD D/R
	Active

(4) AUX3

Press UP or DN to enter the AUX3 interface. Press R or L can change the AUX3 switch. It includes FMOD SW, MIX SW, ELEV D/R, AILE D/R, RUDD D/R, GEAR SW, SPSO SW, SPS1 SW, SPS2 SW, SPS3 SW, Left Trim, Right Trim, AUX4 KB, AUX5 KB, AUX6 KB, AUX7 KB. The default setting is RUDD D/R switch.

Device Output	
Gear	GEAR SW Active
Flap	System System
AUX2	FMOD SW Gyro
AUX3	RUDD D/R Active

Press UP or DN to select the Function setting, press R or L to choose the switch, it includes inhibit, Active, Gyro, Governor, Pitch. The default setting is Active. You can continue to set other items after finished .

(5) AUX4, AUX5, AUX6, AUX7 settings please refers to the AUX3 settings. AUX4 default setting is AUX4 KB; AUX5 default setting is AUX5 KB; AUX6 default setting is AUX6 KB; AUX7 default setting is AUX7 KB.

After finished the setting, press EXT to exit.

2.11 Wing Type

Wing Type is grouped into Nomal, Flaperon, Delta, 4-Aileron and V -Tail.

Press ENT to enter Main Menu, press UP or DN to move navigation mark to Model Menu. Press ENT to enter Model Menu. Press UP or DN to choose Wing Type, and press ENT to enter the Wing Type interface. Press UP or DN to move navigation mark to Wing Type, press R or L to choose Wing Type. The Wing Type are Nomal, Flaperon, Delta and 4-Aileron.

Wing Type	
Wing Type	Normal
V-Tail	Inhibit
Dual Channels	Inhibit
Mate	Inhibit
Trim	Inhibit
Twin Engine	Inhibit
Trim	Inhibit

(1) Flaperon

Press R or L to choose Flaperon under Wing Type.

Below is the sketch map of Flaperon servos' assignment:

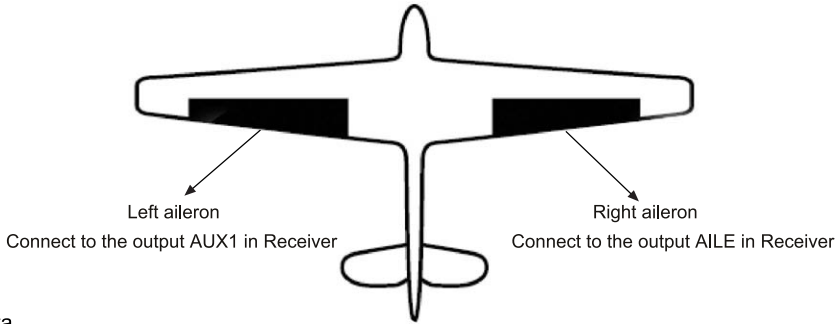

(2) Delta

Press R or L to choose Delta in Wing Type.

Below is the sketch map of Delta servos' assignment:

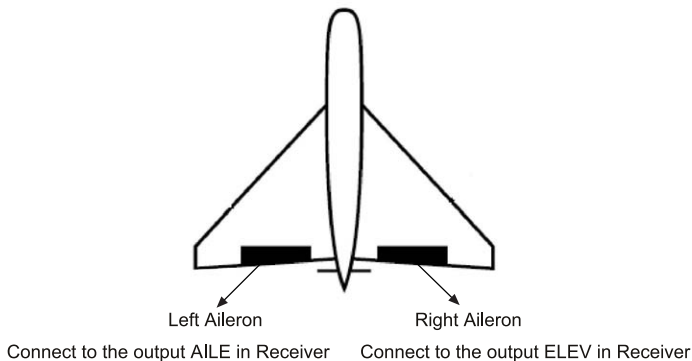

(3) 4-Aileron

If your model airplane is equipped two left aileron servos and two right aileron servos, we recommend you to use 4-Aileron function.

Press R or L to choose 4-Aileron in Wing Type setting. The channel assignment(Refer to Servo monitor):

The left aileron servos should be connected to the Output GEAR and AUX3 in the receiver, and the right aileron servos connected to AILE and GYRO in the receiver. All the servos' parameters can be adjusted respectively.

(4) V-tail

Press UP or DN to move navigation mark to V-TAIL under V-Tail interface. There are Inhibit and Active, please choose Active. V-tail is unadjustable when the Wing type is Delta.

Below is the sketch map of servos' assignment in V-tail:

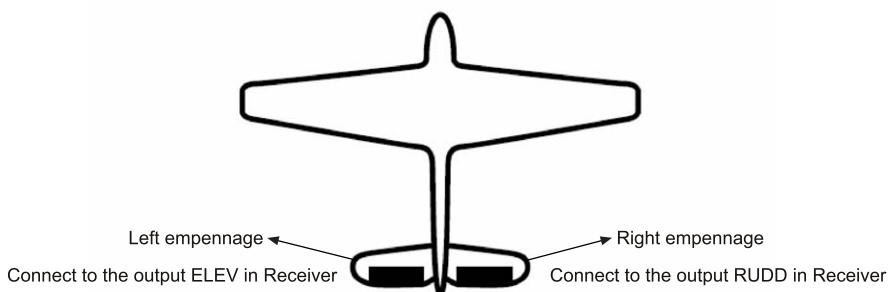

(5) Dual channels setting

Dual Channels can be set as Elevator, Aileron, Rudder, or Flaperon. It is of dual channel output function. The channel, which will be set as dual channel at AUX in Device Output (Refer to "2.10 Device Output"), should be previously set as Inhibit when the AUX channel is being set.

Channel setting: Press UP or DN to move the navigational mark to item Dual Channels in the interface of Wing Type. Pressing R or L, there are items of Elevator, Aileron, Rudder, and Flap. We take Elevator as an example.

Wing Type	
Wing Type	Normal
V-Tail	Inhibit
Dual Channels	Elevator
Mate	AUX4
Trim	Inhibit
Twin Engine	Inhibit
Trim	Inhibit

(5.1) Mate setting:

Press UP or DN to select "Mate Channels" setting, press R or L to select the desired channel in the menu with Inhibit and the inhibited channels previously set in "Device Output".

Wing Type	
Wing Type	Normal
V-Tail	Inhibit
Dual Channels	Elevator
Mate	Inhibit
Trim	Inhibit
Twin Engine	Inhibit
Trim	Inhibit

(5.2) Trim Setting:

Press UP or DN to select "Trim Channels" setting, press R or L to select the item you want to choose as trim lever in the menu with Inhibit, Left trim, Right Trim, AUX4 KB, AUX5 KB, AUX6 KB, AUX7 KB.

Attention: Trim can only be enabled after starting Mate.

Wing Type	
Wing Type	Normal
V-Tail	Inhibit
Dual Channels	Elevator
Mate	AUX4
Trim	Inhibit
Twin Engine	Inhibit
Trim	Inhibit

The setting of Aileron, Rudder and Flap in the item Channel are same as above.

(6) Twin Engine

This function can be set as twin engine output to meet the requirement for the models, which are powered by twin engines.

(6.1) Twin Engine setting:

Press UP or DN to select “Twin Engine” setting, press R or L to choose the desired channel in the menu with Inhibit and the inhibited channels previously set in “Device Output”.

Wing Type	
Wing Type	Normal
V-Tail	Inhibit
Dual Channels	Elevator
Mate	AUX4
Trim	Inhibit
Twin Engine	AUX5
Trim	Inhibit

(6.1) Twin Engine setting

Wing Type	
Wing Type	Normal
V-Tail	Inhibit
Dual Channels	Elevator
Mate	AUX4
Trim	Inhibit
Twin Engine	AUX5
Trim	Inhibit

(6.2) Trim Setting

(6.2) Trim Setting:

Press UP or DN to select “Trim Channels” setting, press R or L to choose the item that you want to select as trim lever in the menu with Inhibit, Left trim, Right Trim, AUX4 KB, AUX5 KB, AUX6 KB, and AUX7 KB. After the setting, press EXT to exit.

Attention: Trim can only be enabled after starting Twin Engine.

2.12 Power Amplifier

The transmission output power of DEVO F12E is adjustable. It is divided into six grades from small to big. The lower the transmission output power transmits, the shorter the radio range is, and the longer the stand-by time will be, the higher the transmission output power, the farer the radio range, and the shorter the stand-by time. Choose the appropriate transmission output power according to the actual situation.

Press ENT to enter Main Menu, press UP or DN to move navigation mark to Model Menu. Press ENT to enter Model Menu. Press UP or DN to select Power Amplifier and press ENT to enter Power Amplifier interface.

Power Amplifier	
+20 dBm	
+15 dBm	
✓ +10 dBm	
+5 dBm	
0 dBm	
-5 dBm	

Press UP or DN to choose the desired output power value. Press ENT to confirm then the corresponding items will have "✓"mark in front of the items.

After the setting, press EXT to exit.

Grade 6	Grade 5	Grade 4	Grade 3	Grade 2	Grade 1
20dBm	15dBm	10dBm	5dBm	0dBm	-5dBm

2.13 Fixed ID

This setting will bind DEVO F12E with its receiver in a unique corresponding relationship. It will greatly speed up the time of automatic binding when DEVO F12E powered on.

(1) Setting for fixed ID

The setting for fixed ID should be under the status that automatic ID binding is successfully finished. Below is the setting method.

Press ENT to enter the main Menu and press UP or DN to move the navigational mark to select Model menu. Press ENT to enter Model Menu. Press UP or DN to select Fixed ID and press ENT to enter the Fixed ID setting interface.(Fig. 1)

If you want to activate the fixed ID settings, press R or L to change the status from off to ON. A series of random digits will be shown below after change to On. (Fig. 2)

Press UP or DN to choose the ID code setting, press R or L to choose the digits,press UP or DN to move to the next code setting . there are 6 digits can be setted. (Fig. 3)

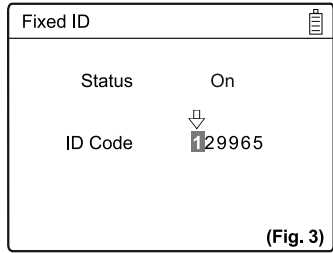
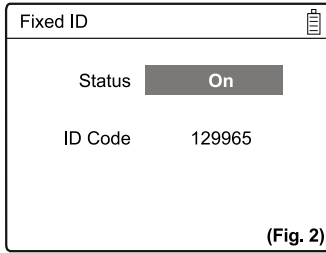
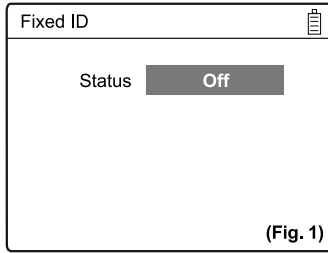

Press ENT key after the new ID has been set. An inquiry interface of “Are you sure?” pop up. “ID Code Matching” will be shown after press ENT. After matching, the interface will be returned to Model Menu.

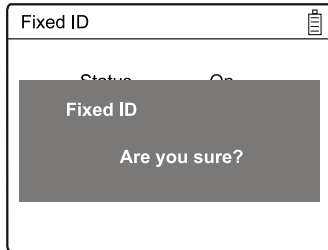

(2) Fixed ID cancellation

Insert the assorted BIND PLUG into the output terminal of BATT before the receiver is powered on, and then plug 5V DC power into other output terminal. The red light of receiver will flash slowly. This means the fixed ID code has been cancelled. Pull out bind plug. DEVO F12E also needs to make relative cancellation and revision after the fixed ID in receiver is cleared out.

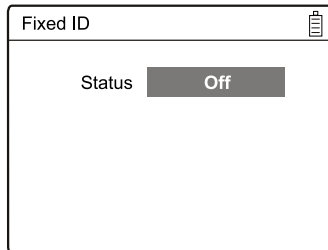

In the main interface press the ENT to enter Model Menu and then press UP or DN to move the navigational mark to select Model Menu. Press ENT to enter Model Menu. Press UP or DN to select Fixed ID code and press ENT to enter the Fixed ID code interface. Press UP or DN to select Status option, Press R or L to change the status to Off. Then press EXT to exit.

2.14 Sensor setting

Setting method: press ENT enter to the Main Menu. Press UP or DN to select the Model Menu. Press ENT enter to Model Menu. Press UP or DN to select sensor press ENT enter to the sensor setting interface. See the Illustration.

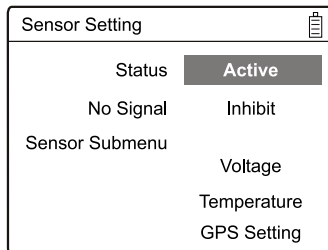

Press R or L to select Activate or Inhibit (the default setting is Inhibit), such as press Activate will includes No Signal Warning, Voltage sensor, Temperature sensor, GPS receiver setting etc.

(1) No Signal

Press UP or DN to make the navigation mark to choose "No Signal". Press R or L to choose "Inhibit" or "Active"(default setting is "inhibit"). If you choose "Active", the Radio will alarm when telemetry signal lost. Picture as left:

(2) Voltage setting

There are 3 different types of voltage can be measured. It includes Interna:V0, External:V1 and V2 which can be monitored two different external voltage(i.e. battery) respectively. Once the measured voltage is lower than the setting value, the Radio will alarm.

(2.1) Receiver V0(Internal) PFV(Power Feeding Voltage) Alarmed value can be set as 3.6-6V

Voltage	
Internal: V0	Inhibit
External: V1	Inhibit
External: V2	Inhibit

Voltage	
Internal: V0	Active 3.6V
External: V1	Inhibit
External: V2	Inhibit

Voltage setting: press R or L to activate the V0, the alarm interface will appear in the interface, please refer to the illustration.

Press UP or DN to select the Alarm Voltage setting, press R or L to set the value. The range is 3.6-6V. you can continue to set other items after you finished.

(2.2) External:V1

Press UP or DN enter to External:V1 setting interface. Press R or L to activate the V1, the details refers to the illustration.

Press UP or DN to select the Alarm Voltage setting. Press R or L to set the value. The setting range is 0.2~99.9V. you can continue to set other items after you finished.

Voltage	
Internal: V0	Inhibit
External: V1	Inhibit
External: V2	Inhibit

Voltage	
Internal: V0	Inhibit
External: V1	Active 0.2 V
External: V2	Inhibit

(2.3) External: V2 setting can refer to External V1 setting.

Press EXT back to sensor setting interface after you finished.

(3) Temperature sensor

The temperature sensor can measure up to 4 different temperature(i.e.motors).You can choose Celsius or Fahrenheit.The alarmed value can be set to 4 different temperature.Once the measured value is higher than the setting value, the radio will alarm.The Alarm Temperature value can be set as -20~220 °C or -4.0~428.0° F.

Temperature Setting:

In the “Sensor Setting”interface, press UP or DN to make the navigation mark to choose “Temperature Sensor”, and press ENT to enter “Temperature Sensor”setting interface. See the illustration.

Temperature	
Unit	Celsius
Temp. T1	Inhibit
Temp. T2	Inhibit
Temp. T3	Inhibit

(3.1) Unit

Press UP or DN to make the navigation mark to choose “Unit”setting item, and press R or L to choose Unit, two kinds of Unit:Celsius and Fahrenheit.

(3.2) Alarm Temperature settings

Press UP or DN select the T1, Press R or L to Active the setting. Inhibit will change to Active and Alarm temperature will be shown. If you choose Inhibit, the Alarm temperature value won't be shown.

Temperature	
Unit	Celsius
Temp. T1	Active 100 °C
Temp. T2	Inhibit
Temp. T3	Inhibit

Press UP or DN to select “Alarm”setting, press R or L to set the alarm temperature value. Press UP or DN to set other items after finishing the setting.

(3.3) T2, T3, T4 setting

Refer to the step of “(3.2)T1”.

(4) GPS setting

There are 4 items including Altitude Type,Speed Unit, Date Type and Time Zone in the GPS receiver setting interface.

GPS Setting	
Altitude Type	Absolute
Speed Unit	Knots
Date Type	DD-MM-YY
Time Zone	UTC+08:00

Press UP or DN to select the Sensor setting interface to enter the GPS setting interface.

(4.1) Altitude Type

Press UP or DN to select the Altitude type on the GPS setting interface and it's Absolute and Relative.

(4.2) Speed Unit

Press UP or DN to select the Speed Unit on the GPS setting interface and it includes knots and km/h and relative. Select the desired item.

GPS Setting	
Altitude Type	Absolute
Speed Unit	Knots
Date Type	DD-MM-YY
Time Zone	UTC+08:00

GPS Setting	
Altitude Type	Absolute
Speed Unit	Km/h
Date Type	DD-MM-YY
Time Zone	UTC+08:00

(4.3) Date Type

Press UP or DN to select the Date Type on the GPS setting interface and it includes DD-MM-YY,MM-DD-YY and YY-MM-DD. Select the desired item.

GPS Setting	
Altitude Type	Absolute
Speed Unit	Knots
Date Type	DD-MM-YY
Time Zone	UTC+08:00

(4.3) Date Type

GPS Setting	
Altitude Type	Absolute
Speed Unit	Knots
Date Type	DD-MM-YY
Time Zone	UTC+08:00

(4.4) Time Zone

(4.4) Time Zone

Press UP or DN to select the Time Zone, press R or L to set the desired Time Zone.

3.0 Function Menu

Function Menu can help you custom adjustments for the selected models. The menu includes such items as Reverse Switch, Travel Adjust, Sub Trim, Dual Rate and Exponential, Throttle Hold, Throttle Curve, Differential,Balance,Gyro Sensor, Governor, Aileron to Rudder Mix, Elevator to Flap Mix, Rudder to Aileron/Elevator Mix, Flap System, Aileron to Flap Mix, Pitch Curve, Program Mix, Monitor, Fail Safe, Sensor view, Trainer and Timer.

3.1 Reverse Switch

Press ENT to enter Main Menu; Press UP or DN to move the navigation mark to Function Menu, and press ENT to enter Function Menu. Press UP or DN to choose Reverse Switch and Press ENT to enter Reverse Switch interface.

Reverse Switch	
Elevator	Reverse
Aileron	Normal
Throttle	Normal
Rudder	Normal
Gear	Normal
Flap	Normal
Gyro	Normal
AUX3	Normal

Press UP or DN to move navigation mark to ELE(take Elevator for example), press R or L to shift the status between normal and reverse. These are two status for option. And the default setting is Normal. All Channels Reverse Switch like: Aileron, Throttle, Rudder, Gear, Flap, Gyro, AUX3, AUX4, AUX5, AUX6 and AUX7 can be referred to the way of ELEV Reverse Switch. And press EXT to exit after finishing setting.

Reverse Switch	
Elevator	Normal
Aileron	Normal
Throttle	Normal
Rudder	Normal
Gear	Normal
Flap	Normal
Gyro	Normal
AUX3	Normal

3.2 Travel Adjust

Press ENT to enter into Main Menu. Press UP or DN to move navigation mark to select item Function Menu. Press ENT to enter Function Menu. Press UP or DN to select Travel Ajust, Press ENT to enter Travel Adjust interface, as below illustration. It shows the Travel Adjust status of one channel:

Travel Adjust	
Elevator	U100.0%
	D100.0%
Aileron	L100.0%
	R100.0%
Throttle	H100.0%
	L100.0%
Rudder	L100.0%
	R100.0%

Take ELEV for example, Press UP or DN to move navigation to desired item Elevator of U. Press R or L to increase or decrease the servo travel range. The adjustment range is from 0.0% to 150.0%. The factory default is 100.0%. Press UP or DN to move navigation mark to desired item Elevator of D. Press R or L to increase or decrease the servo travel range. The adjustment range is from 0.0% to 150.0%. The factory default is 100.0%. All other channel's Travel Adjust like Aileron, Throttle, Rudder, Gear ,Flap, Gyro, AUX3, AUX4, AUX5, AUX6 and AUX7 can be referred to Elevator travel Ajust. Press EXT to exit after setting finished.

3.3 Sub Trim

Sub Trim can move the neutral point of the servo. But we advise you to mechanically adjust the servo bell crank if offset is far away from the neutral point of servo, because excessive usage of the sub trim may damage the servo.

Press ENT to enter Main Menu, Press UP or DN to move the navigation mark to select item Function Menu. Press ENT to enter Function Menu, Press UP or DN to select Sub trim, and press ENT to enter Sub Trim interface.

Sub Trim	
Elevator	0.0%
Aileron	0.0%
Throttle	0.0%
Rudder	0.0%
Gear	0.0%
Flap	0.0%
Gyro	0.0%
AUX3	0.0%

The interface show the items and the channels which are adjustable. Press R or L to change the neutral point of Servos. The factory default is 0.0%. Press UP or DN to choose desired items. The range as below:

Channel name	Adjustment range	Channel name	Adjustment range
Elevator	D62.5% ~ U62.5%	Gyro	-62.5% ~ +62.5%
Aileron	R62.5% ~ L62.5%	AUX3	-62.5% ~ +62.5%
Throttle	L62.5% ~ H62.5%	AUX4	-62.5% ~ +62.5%
Rudder	R62.5% ~ L62.5%	AUX5	-62.5% ~ +62.5%
Gear	-62.5% ~ +62.5%	AUX6	-62.5% ~ +62.5%
Flap	D62.5% ~ U62.5%	AUX7	-62.5% ~ +62.5%

Press EXT to exit after adjustment finished.

3.4 Dual rate and Exponential

After this function is set up, it is possible for D/R switches to control the dual rates of elevator, aileron and rudder, respectively. The setting range is covered from 0% to 125%. Under the help with exponential curve adjustment, it is possible to make both customized setting and automatic setting. The switch between Dual rate and Exponential can be performed via pushing or pulling the Flight Mode Lever.

Setting method:

Press ENT to enter Main Menu. Press UP or DN to move navigation mark to desired item Function Menu. Press ENT to enter Function Menu, press UP or DN to choose Dual rate and Exponential, Press ENT to enter D/R and Exponential interface.

Dual Rate and Exponential	
	Pos 0
Channel	Elevator
Position	Pos 0
Dual Rate	100%
Exponential	Line
Flight Mode 0	Switch
Flight Mode 0 1	Switch
Flight Mode 0 2	Switch

(1) Channel selection

Press UP or DN to move navigation mark of Channel, Press R or L to set up channels containing Elevator, Aileron and Rudder. Choose the desired channel for setting.

(2) Position selection

Press UP or DN to move navigation mark to desired item Position.

In the manual mode, the function of Dual rate and Exponential will be executed by the corresponding D/R switch among Pos0 and Pos1. Take the item Elevator at channel as an example. It's possible to shift between Pos0 and Pos1 via pushing or pulling the D/R switch.



Dual Rate and Exponential		Pos 0
Channel	Elevator	
Position	Pos 0	
Dual Rate	100%	
Exponential	Line	
Flight Mode 0	Switch	
Flight Mode 1	Switch	
Flight Mode 2	Switch	

(3) Dual Rate adjustment

Press UP or DN to move the navigation mark to desired item Dual Rate, press R or L to change the number and then you can change the dual rate of the position. The factory default setting is 100%.

Dual Rate and Exponential		Pos 0
Channel	Elevator	
Position	Pos 0	
Dual Rate	100%	
Exponential	Line	
Flight Mode 0	Switch	
Flight Mode 1	Switch	
Flight Mode 2	Switch	

(4) Exponential

Press UP or DN to select Exponential item of navigation mark. It's possible to change Dual Rate and Exponential value in Pos when pressing R or L to change the value. There are ± 100% and Line three adjustment.

(5) Automatic setting

Under working with Flight Mode, it's possible to switch the dual rate and exponential, which are set in above"(3) Dual Rate adjustment" and "(4) Exponential adjustment", respectively.



The settings for Flight Mode 0, Flight Mode 1, Flight Mode 2, Flight Mode 3, Flight Mode 4 are available.

Note: If want to use this function, it is necessary to previously set both "Flight Main Switch" and "Flight Extra Switch" at Device Select in Model Menu as the corresponding switches. Refer to "2.9 Device Select".

(5.1) Flight Mode 0 setting:

Press UP or DN in the navigation mark of Dual rate and Exponential to select the desired item Flight Mode 0. Press R or L to set the position and the Switch. Only the D/R switch control is valid When Switch is selected, under the Flight Mode, it's possible for Pos to switch the dual rate and exponential, which are set in above(3) and (4)Exponential adjustment. The settings for Switch, Pos0, Pos1, Pos2 , Pos3, Pos4 are valid.

Dual Rate and Exponential		Pos 0
Channel	Elevator	
Position	Pos 0	
Dual Rate	100%	
Exponential	Line	
Flight Mode 0	Switch	
Flight Mode 1	Switch	
Flight Mode 2	Switch	

(5.2) The setting for Flight Mode 1, Flight Mode 2, Flight Mode 3, Flight Mode 4 can be set up according to above Flight Mode 0 Setting.

Press EXT to exit after finishing the setting.

3.5 Throttle Hold

If this function is set, the switch will be executed by hold switch. The setting value of throttle hold is ranged from -20.0-50.0%. the default setting is Inhibit.

Welcome to use the DEVO F12E transmitter

Setting method:

Press ENT to enter Main Menu, Press UP or DN to move navigation mark to select Function Menu. Press ENT to enter Function Menu. Press UP or DN to select Throttle Hold, Press ENT to enter Throttle Hold interface, as below illustration:

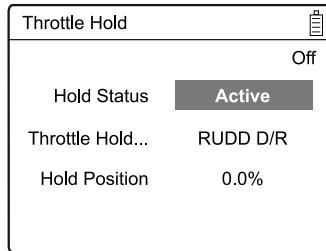
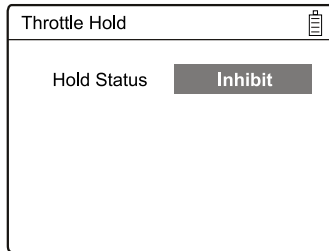

Press R or L to activate Throttle Hold function, and expansion list will be shown as Hold status, Throttle Hold Switch, Hold Position.

(1) There are two items under Throttle Hold Status: Active and Inhibit. The factory default setting is Inhibit.

(2) Throttle Hold Switch setting

It's invalid for setting, the factory default is RUDD D/R which will be shown in the status item. When the Throttle Hold switch is on, data under the Throttle Hold can not be amended until Throttle Hold switch to be off, and the hold status is changed.

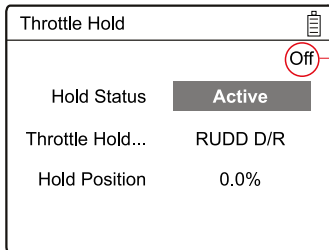

Display of switch status



(3) Hold Position

In the Throttle Hold interface, press UP or DN to make the Navigation mark to choose "Hold Position" setting options. Press R or L to change data, the minimum value is -20.0%; the maximum value is +50.0%.

Press EXT to exit after finishing the setting.

3.6 Throttle Curve

Throttle Curve are adjusted through 7 points.

Press ENT to enter main menu, Press UP or DN to move navigation mark to select Function Menu. Press ENT to enter Function Menu. Press UP or DN to select Throttle Curve, Press ENT to enter Throttle Curve interface. The enquiry dropdown is shown "All servos hold?" If select OK, all the servos will be locked at the current status, if click Cancel, all the servos will be unlocked at the current status.

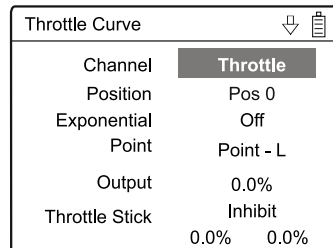
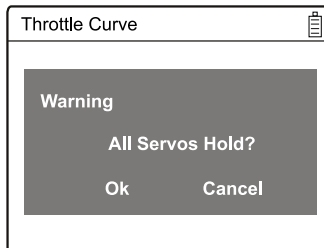

(1) Channel setting

The default setting is Throttle Channel, and can not reset.

(2) Position selection

Press UP or DN in the "Throttle Curve" setting interface to select "Position", press R or L to select the item you want to set in the list with Pos 0 and Pos 1.

(3) Exponential setting

Press UP or DN in the "Throttle Curve" setting interface to select "Exponential" setting, Press R or L to set "Off" or "On". Select On for smooth changes, and Off for changes in the form of fold ling in throttle curve, respectively.

(4) Curve setting

Including "Point" and "Output".

(4.1) Point setting

Press UP or DN in Throttle Curve interface to select Points setting. Press R to expand a list including seven points: "Point-L", "Point-1", "Point-2", "Point-M", "Point-3", "Point-4" and "Point-H". Press R or L to select the point you want to adjust.

Throttle Curve	
Channel	Throttle
Position	Pos 0
Exponential	Off
Point	Point - L
Output	0.0%
Throttle Stick	Inhibit
	0.0% 0.0%

Throttle Curve	
Channel	Throttle
Position	Pos 0
Exponential	Off
Point	Point - 1
Status	Inhibit
Throttle Stick	Inhibit
	0.0% 0.0%

Throttle Curve	
Channel	Throttle
Position	Pos 0
Exponential	Off
Point	Point - 1
Status	Inhibit
Output	16.5%
Throttle Stick	Inhibit
	0.0% 0.0%

(4.2) Status setting

Press UP or DN to move navigation mark to Status and press R or L to choose Inhibit or Active. Select Inhibit if keeping the current value(the default setting is Inhibit). Select Active for changing the above points' value.

Note: After select point -L or Point-H, the status setting won't be display.

(4.3) Output setting

There is a expand item "Output" after select Status Active, press UP or DN to select Output setting, press R or L to increase or decrease, respectively, the output value. The adjustable range is from 0.0% to 100.0%.

Throttle Curve	
Channel	Throttle
Position	Pos 0
Exponential	Off
Point	Point - 1
Status	Inhibit
Output	16.5%
Throttle Stick	Inhibit
	0.0% 0.0%

Throttle Curve	
Channel	Throttle
Position	Pos 0
Exponential	Off
Point	Point - 1
Status	Inhibit
Output	16.5%
Throttle Stick	Inhibit
	0.0% 0.0%

(5) Throttle Stick setting

The switch between Pos 1 and Pos 0 can be freely realized through throttle stick after the below amount has been set up. The below set amount is the position of throttle stick as well as the switch point.

Throttle Stick setting: Press UP or DN to select Throttle Stick setting, Press L to decrease the amount with a lower limit of 0.0% or Inhibit, Press R to increase the amount with an upper limit of 100.0%.

(6) Switch Selection

When the item Throttle Stick is set in Inhibit, it is possible to switch between Pos 0 and Pos 1 by Switch.

Press UP or DN to select "Switch". Press ENT to enter Switch interface, press UP or DN to choose desired item. Press ENT to confirm, the desired item whose left side will be changed into "1" from "0". If two or more items are selected, the item And should be selected, whose left side should be changed into "1" from "0". Press EXT after finished it.

Throttle Curve	
Position	Pos 0
Exponential	Off
Point	Point - 1
Status	Inhibit
Output	16.5%
Throttle Stick	Inhibit
Switch	Pos 0
	0.0% 0.0%

Switch	
ⓐ And	
ⓐ Flight Mode 0	
ⓐ FMOD 1	
ⓐ FMOD 2	
ⓐ Flight Mode 3	
ⓐ Flight Mode 4	
ⓐ Flap Normal	
ⓐ Flap Midpoint	

3.7 Differential

If want to use this function, Flaperon, Delta, or 4-Aileron should be previously selected in Wing Type of Model Menu. Refer to “2.11 Wing Type”.

(1) Aileron differential setting

Press ENT to enter Main menu; press UP or DN to choose Function menu. Press ENT to enter Function menu; press UP or DN to choose Differential, press ENT to enter interface of Differential, illustration as below.

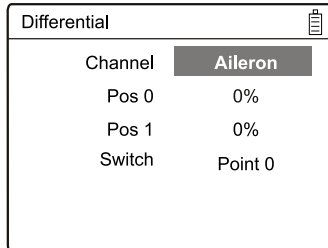

Mounting servos in left and right ailerons are a must if using this function. The following interface will be shown after Flaperon, Delta, or 4-Aileron selected in Wing Type. Refer to “2.11 Wing Type”.

(1.1) Channel: Current setting channel is Aileron. System default can not be set.

(1.2) Setting for Pos 0

Press UP or DN to choose Pos 0, press R or L to increase or decrease differential value, respectively. The adjustable range is $\pm 100\%$.

(1.3) Setting for Pos 1

Press UP or DN to choose Pos1, press R or L to increase or decrease differential value, respectively. The adjustable range is $\pm 100\%$.

(1.4) Switch selection

It is possible to switch by Setting Switch when differential is in use.

Press UP or DN to choose Switch, press ENT to enter interface of Switch selection, press UP or DN to choose desired item. Press ENT to confirm, the desired item whose left side will be changed into “1” from “0”. If two or more items are selected, the item And should be selected, whose left side should be changed into “1” from “0”. Press EXT after finished it.

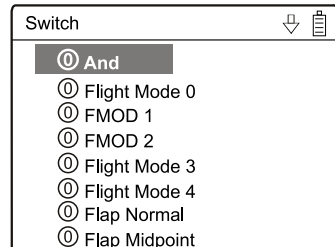
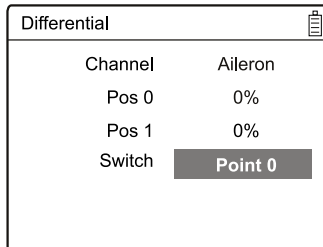

(2) Rudder differential setting

V-Tail should be previously set in Wing Type of Model Menu if the rudder differential function is activated. Refer to “2.11 Wing Type”. And then the following interface will be shown:

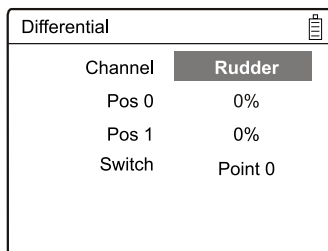

(2.1) Channel

press UP or DN to move the navigational mark to the item Channel and press R or L to choose the channel Rudder.

(2.2) Setting for Pos 0

Press UP or DN to choose Pos 0, press R or L to increase or decrease differential value, respectively, the value with a range of $\pm 100\%$.

(2.3) Setting for Pos 1

Press UP or DN to choose Pos1, press R or L to increase or decrease differential value, respectively, the value with a range of $\pm 100\%$.

(2.4) Switch selection

It is possible to switch by Setting Switch when differential is in use.

Press UP or DN to choose Switch, press ENT to enter interface of Switch selection, press UP or DN to choose desired item. Press ENT to confirm, the desired item whose left side will be changed into “1” from “0”. If two or more items are selected, the item And should be selected, whose left side should be changed into “1” from “0”. Press EXT after finished it.

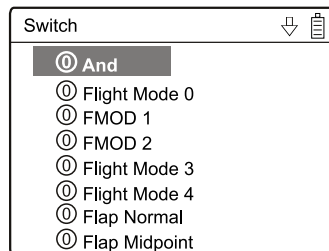
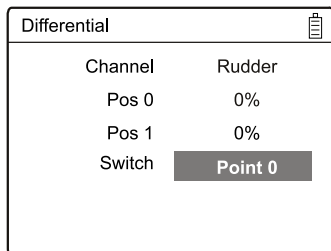

(3) Flap differential setting

It should be previously set the flap dual channel function in Wing Type of Model Menu (refer to “2.11 Wing Type”) in order to activate the menu of Flap Differential.

(3.1) Channel

press UP or DN to move the navigational mark to the item Channel and press R or L to choose the channel Flap.

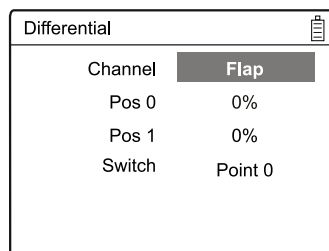

(3.2) Setting for Pos 0

Press UP or DN to choose Pos 0, press R or L to increase or decrease differential value, respectively. The adjustable range is $\pm 100\%$.

(3.3) Setting for Pos 1

Press UP or DN to choose Pos1, press R or L to increase or decrease differential value, respectively. The adjustable range is $\pm 100\%$.

(3.4) Switch selection

It is possible to switch by Setting Switch when differential is in use.

Press UP or DN to choose Switch, press ENT to enter interface of Switch selection, press UP or DN to choose desired item. Press ENT to confirm, the desired item whose left side will be changed into “1” from “0”. If two or more items are selected, the item And should be selected, whose left side should be changed into “1” from “0”. Press EXT after finished it.

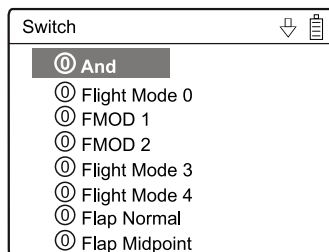
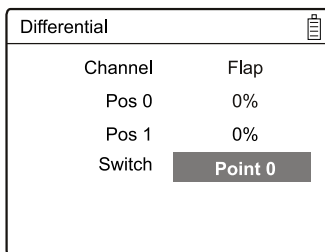

3.8 Balance

This function can adjust the parameters of the two servos which are used in the dual channels. It should be previously activated one of these wing types of Flaperon, Delta, 4-Aileron, and V-Tail in Wing Type at Model Menu. Refer to “2.11 Wing Type”.

Press ENT to enter Main Menu, press UP or DN to choose Function. Press ENT to enter Function menu, press UP or DN to choose Balance. Press ENT to enter interface of Balance setting, picture as right:

(1) Channel: current setting channel is Aileron. System default can not be set.

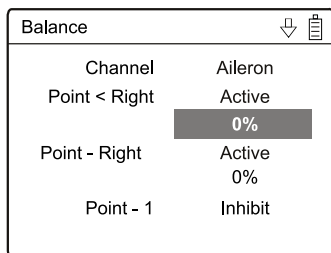
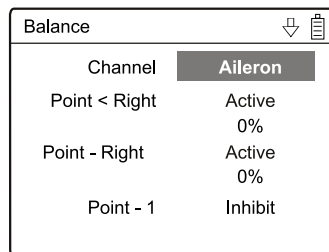

(2) Point parameter adjustment

Point< Right Setting: Press UP or DN to choose “Point< Right”. If need to adjust the value, press L (0% means no adjusting). A minus value means the amending direction is downward; press R to adjust value(0% means no adjusting). A plus value means the amending direction is upward. The adjustable range is $\pm 100\%$.

Point-Right Setting: Press UP or DN to choose "Point-Right". Press R or L to Inhibit or Active. If need to adjust please Active it. There will be expanded value adjustment item. Press UP or DN to choose "0%" If need to adjust the value, press L (0% means no adjusting). A minus value means the amending direction is downward; press R to adjust value (0% means no adjusting). A plus value means the amending direction is upward. The adjustable range is 100%.

Balance		↓ ↑
Channel	Aileron	
Point < Right	Active	0%
Point - Right	Active	0%
Point - 1	Inhibit	

Press UP or DN, there will be setting for Point-1, Point-2, Point-3, Point-Left, Point>Left, refer to the setting method as above. Press EXT after finished it.

3.9 Gyro Sensor

This function offers the gain adjustment for gyro sensor, which can be manually set through D/R switches or Flight mode switch, and also is possible to be automatically switched among various gains through flight mode switch. (The flight mode should be activated. Refer to "2.9 Device Select").

Setting method:

Press ENT to enter Main menu; Press UP or DN to choose Function menu. Press ENT to enter Function menu; Press UP or DN to choose Gyro Sensor setting, press ENT to enter the setting interface of Gyro Sensor setting.

Gyro Sensor		↓ ↑
		Pos 0
Mode	Manual	
Channel	AUX2	
Switch	ELEV D/R	
Pos 0	50.0%	
Pos 1	50.0%	

(1) Manual Setting

(1.1) Manual Setting:

Under Gyro setting interface, press UP or DN to choose Mode, press R or L to select Manual setting or Automatic Setting (Automatic setting can be activated if Flight mode is act, refer to "2.9 Device selection"). Choose "Manual Setting"

(1.2) Channel:

The default setting is AUX 2. It is possible to alter into other channels in the interface of Device Output (Refer to "2.10 Device Output").

(1.3) Switch selection:

Under Gyro setting interface, press UP or DN to choose Switch, press R or L to expand into six articles: FMOD SW, MIX SW, ELEV D/R, AILE D/R, and RUDD D/R, GEAR SW. Choose the desired switch for Manual control.

(1.4) Sensitivity Setting

If choose 3 switches, there are "Pos 0", "Pos 1" and "Pos 2", then set the sensitivity individually; If choose 2 switches, there are "Pos 0" and "Pos 1", then set the sensitivity individually.

Gyro Sensor		↓ ↑
		Pos 0
Mode	Manual	
Channel	AUX2	
Switch	ELEV D/R	
Pos 0	50.0%	
Pos 1	50.0%	

Pos 0 ← Display the current switch position

(1.4.1) Status:

Turn the setting gyro control switch, the status items will display the current switch status position.

(1.4.2) Pos 0:

Press UP or DN to move the navigational mark to Pos 0 and press R or L to increase or decrease, respectively, the value. If the gyro used has two modes of NOR and AVCS, NOR will be activated when the value is less than 50.0%. In NOR mode, the smaller the value is, the bigger the gyro sensor sensitivity will be. The factory setting is 50.0%.

(1.4.3) "Pos 1", "Pos 2" are the same setting way as above "Pos 0".

Gyro Sensor		↓ ↑
		Pos 0
Mode	Manual	
Channel	AUX2	
Switch	ELEV D/R	
Pos 0	50.0%	
Pos 1	50.0%	

(2) Automatic setting

(2.1) Automatic Setting:

Under Gyro setting interface, press UP or DN to choose Mode, press R or L to select Manual setting or Automatic Setting. Choose "Automatic Setting"

(2.2) Channel:

The default setting is AUX 2. It is possible to alter into other channels in the interface of Device Output (Refer to "2.10 Device Output").

(2.3) Switch: The switch function isn't available under Automatic setting.

(2.4) Status:

Turn the Flight Mode Switch, the status display present flight mode position. There are "Flight Mode 0", "Flight Mode 1", "Flight Mode 2", "Flight Mode 3", "Flight Mode 4" sets. For Flight Mode 3 and Flight Mode 4, Flight Mode Extra Switch should be activated in Device Select (Refer to "2.9 Device Select").

Gyro Sensor		Flight Mode 0
Mode	Automatic	
Channel	AUX2	
Switch	ELEV D/R	
Flight Mode 0	50.0%	
Flight Mode 1	50.0%	
Flight Mode 2	50.0%	

Gyro Sensor		Flight Mode 0
Mode	Automatic	
Channel	AUX2	
Switch	ELEV D/R	
Flight Mode 0	50.0%	
Flight Mode 1	50.0%	
Flight Mode 2	50.0%	

Display present flight mode position

(2.5) Flight Mode 0:

Press UP or DN to select Flight Mode 0, press R or L can increase or decrease the value individually. If the gyro used has two modes of NOR and AVCS, NOR will be activated when the value is less than 50.0%. In NOR mode, the smaller the value is, the bigger the gyro sensor sensitivity will be. The factory setting is 50.0%.

(2.6) Flight mode 1, Flight mode 2, Flight mode 3, Flight mode 4 settings refer to "Flight Mode 0".

After finishing the set, press EXT to exit.

Gyro Sensor		Flight Mode 0
Mode	Automatic	
Channel	AUX2	
Switch	ELEV D/R	
Flight Mode 0	50.0%	
Flight Mode 1	50.0%	
Flight Mode 2	50.0%	

3.10 Governor

Before setup this function, "Governor" should be set and activated in "Device output" interface. (Refer to 2.10 Device Output)

The control proportion of governor can be separately set in various flight modes. For the absolute revolution amount, please set in external governor. The amount shown in DEVO F12E governor is just a percentage for reference. The actual revolution should be read in the external governor.

Press ENT to enter the "Main menu" interface; Press UP or DN to make the navigation mark to select "Function menu". Press ENT to "Function menu"; Press UP or DN to choose "Governor" then press ENT to enter the Governor setting interface, which display the options of Status and channels; Press UP or DN, there are options of "Flight Mode 0", "Flight Mode 1", "Flight Mode 2", "Flight Mode 3", "Flight Mode 4" and so on.

(1) Status

Turn the Flight Mode switch, the status display present flight mode position. There are "Flight Mode 0", "Flight Mode 1", "Flight Mode 2", "Flight Mode 3", "Flight Mode 4" sets. For Flight Mode 3 and Flight Mode 4, Flight Mode Extra Switch should be activated in Device Select (Refer to "2.9 Device Select").

Governor		Flight Mode 0
Channel	AUX2	
Flight Mode 0	0%	
Flight Mode 1	0%	
Flight Mode 2	0%	
Flight Mode 3	0%	
Flight Mode 4	0%	

(2) Channel: The setted channels will display in “2.10 Device output” (refer to 2.10 Device Output)

(3) Flight Mode 0

Press “UP or DN” to make the navigation choose the “Flight Mode 0”set, press R or L to increase or decrease the value.The factory default value is 0%, adjustable range $\pm 125\%$.

(4) Flight mode 1, Flight mode 2, Flight mode 3, Flight mode 4 settings refer to “Flight Mode 0”.

Press EXT to exit after finished.

3.11 Aileron to Rudder Mix

This function is possible to execute the mix of aileron to rudder, which is controlled by switch.

Press ENT enter to Main menu, press UP or DN to select Function menu. Press ENT enter to Function menu. Press UP or DN select Aileron to Rudder Mix, press ENT to enter Aileron to Rudder Mix setting interface.

Aileron to Rudder Mix		
Pos 0	Left	0%
	Right	0%
Pos 1	Left	0%
	Right	0%
Throttle Stick	Inhibit	
Switch	Pos 0	

(1) Pos 0 Setting leftward setting

Press UP or DN to move the Navigation mark to select "Pos 0 Left" setting options. Press R or L to change mix value of Rudder when moving the aileron stick leftward. It is possible to change the mix direction via changing the plus or minus sign before the value. The adjustable mix is $\pm 125\%$

(2) Pos 0 Setting rightward setting

Press UP or DN to move the Navigation mark to select "Pos 0 Right" setting options. Press R or L to change mix value of Rudder when moving the aileron stick rightward. It is possible to change the mix direction via changing the plus or minus sign before the value. The adjustable mix is $\pm 125\%$

(3) Pos 1 setting, the setting is same as above.

(4) Throttle stick setting

The switch between Pos 0 and Pos 1 can be realized by setting the position of throttle stick. Press UP or DN of Throttle Stick to set the position amount of throttle stick. The default setting is Inhibit. The adjustable range is 0.0-100.0%.

(5) Switch setting

The switch will display the current switch position. Press UP or DN to choose Switch, press ENT to enter interface of Switch selection, press UP or DN to choose desired item. Press ENT to confirm, the desired item whose left side will be changed into “1” from “0”. If two or more items are selected, the item And should be selected, whose left side should be changed into “1” from “0”. Press EXT after finished it.

Aileron to Rudder Mix		
Pos 0	Left	0%
	Right	0%
Pos 1	Left	0%
	Right	0%
Throttle Stick	Inhibit	
Switch	Pos 0	

Switch	
<input checked="" type="radio"/>	And
<input type="radio"/>	Flight Mode 0
<input type="radio"/>	FMOD 1
<input type="radio"/>	FMOD 2
<input type="radio"/>	Flight Mode 3
<input type="radio"/>	Flight Mode 4
<input type="radio"/>	Flap Normal
<input type="radio"/>	Flap Midpoint

3.12 Elevator to flap mix

This function is used to execute the mix of elevator to flap.

Press ENT enter to main menu, press UP or DN to select function menu. Press ENT to enter to function menu. Press UP or DN to select Elevator to flap mix, press ENT to enter to Elevator to flap mix setting interface.

Elevator to Flap Mix		
Pos 0	Up	0%
	Down	0%
Pos 1	Up	0%
	Down	0%
Throttle Stick	Inhibit	
Switch	Pos 0	

(1) Pos 0 UP setting

Press UP or DN to move the navigational mark to select item Pos 0 UP, press R or L upward mix value of Elevator to flap mix will be changed. The mix direction will be revised by changing the sign of plus or minus before the value. The adjustable range is $\pm 125\%$.

(2) Pos 0 Down setting

Press UP or DN to move the navigational mark to select item Pos 0 Down, press R or L downward mix value of Elevator to flap mix will be changed. The mix direction will be revised by changing the sign of plus or minus before the value. The adjustable range is $\pm 125\%$.

(3) Pos 1 setting, the setting is same as above.

(4) Throttle stick setting

The switch between Pos 0 and Pos 1 can be realized by setting the position of throttle stick. Press UP or DN of Throttle Stick to set the position amount of throttle stick. The default setting is Inhibit. The adjustable range is 0.0-100.0%.

(5) Switch setting

The switch will display the current switch position. Press UP or DN to choose Switch, press ENT to enter interface of Switch selection, press UP or DN to choose desired item. Press ENT to confirm, the desired item whose left side will be changed into "1" from "0". If two or more items are selected, the item And should be selected, whose left side should be changed into "1" from "0". Press EXT after finished it.

Elevator to Flap Mix		
Pos 0	Up	0%
	Down	0%
Pos 1	Up	0%
	Down	0%
Throttle Stick	Inhibit	
Switch	Pos 0	

Switch	
<input checked="" type="radio"/>	And
<input type="radio"/>	Flight Mode 0
<input type="radio"/>	FMOD 1
<input type="radio"/>	FMOD 2
<input type="radio"/>	Flight Mode 3
<input type="radio"/>	Flight Mode 4
<input type="radio"/>	Flap Normal
<input type="radio"/>	Flap Midpoint

3.13 Rudder to Aileron/Elevator Mix

This function is used to execute the mix of Rudder to Aileron/Elevator. It will help eliminate waver or shake caused by rudder stick operation.

Setting method:

Press ENT to enter Main Menu, press UP or DN to make the navigation mark to choose "Function Menu". Press ENT to enter "Function Menu", then press UP or DN to choose "Rudder to Aileron/Elevator Mix" and press ENT to enter "Rudder to Aileron/Elevator Mix" setting interface.

Rudder to Aileron/Elevator...		
Elevator	Left	Right
Pos 0	0%	0%
Pos 1	0%	0%
Aileron	Left	Right
Pos 0	0%	0%
Pos 1	0%	0%
Throttle Stick	Inhibit	
Switch	Pos 0	

(1) Elevator setting

(1.1) Elevator Pos 0 Leftward setting

Press UP or DN to make the navigation mark to select "Elevator Pos 0 Left setting" item, and press R or L to change the value and the Elevator mix amount when operating Rudder leftward .The mix direction will be revised by changing the sign of plus or minus before the value.The adjustable range is $\pm 125\%$.

(1.2) Elevator Pos 0 Rightward setting

Press UP or DN to make the navigation mark to select "Elevator Pos 0 Right setting" item, and press R or L to change the value and the Elevator mix amount when operating Rudder rightward .The mix direction will be revised by changing the sign of plus or minus before the value.The adjustable range is $\pm 125\%$.

(1.3) Elevator Pos 1 setting: refer to "1.1 Elevator Pos 0" setting.

(2) Aileron setting

(2.1) Pos 0 setting: refer to "1.1 Elevator Pos 0" setting.

(2.2) Pos 1 setting: refer to "1.1 Elevator Pos 0" setting.

(3) Throttle stick setting

The switch between Pos 0 and Pos 1 can be realized by the position of Throttle Stick,then press R or L to change the value or Inhibit.Change the value to set the Thottle Stick position.The default setting is "Inhibit",the adjustable range is from 0.0 to 100.0%.

(4) Switch setting

The switch will display the current switch position. Press UP or DN to choose Switch, press ENT to enter interface of Switch selection, press UP or DN to choose desired item. Press ENT to confirm, the desired item whose left side will be changed into "1" from "0". If two or more items are selected, the item And should be selected, whose left side should be changed into "1" from "0". Press EXT after finished it.

Rudder to Aileron/Elevator...		
Elevator	Left	Right
Pos 0	0%	0%
Pos 1	0%	0%
Aileron	Left	Right
Pos 0	0%	0%
Pos 1	0%	0%
Throttle Stick	Inhibit	
Switch	Pos 0	

Switch	
And	
Flight Mode 0	
FMOD 1	
FMOD 2	
Flight Mode 3	
Flight Mode 4	
Flap Normal	
Flap Midpoint	

3.14 Flap System

This function can modify some effects on elevator. It is possible to set 3 status of elevator and 3 status of flap system, respectively, through 3-way flap control switch.

Setting method:

Press ENT to enter Main Menu, press UP or DN to make the navigation mark to choose "Function Menu", press ENT to enter Function Menu. Press UP or DN to choose "Flap System" and then ENT to enter its setting interface.

Flap System	
Elevator	Normal 0%
	Midpoint 0%
	Land 0%
Flap	Normal U100%
	Midpoint 0%
	Land D100%

(1) Elevator setting

There are 3 options: 0: Normal; 1: Midpoint and 2: Land.

(1.1) Elevator 0: Normal position

Press UP or DN to make the navigation mark to choose "Elevator 0: Normal", and press R or L to change the elevator mix amount. It is possible to change the direction by altering U or D before the amount. The default setting is 0%, and the adjustable range is U125% - D125%.

(1.2) Midpoint position: Please refer to "1.1 Elevator 0: Normal" setting

(1.3) Land position: Please refer to "1.1 Elevator 0: Normal" setting

(2) Flap setting: the setting for flap is same as elevator.

(3) Status

Press UP or DN to make the navigation mark to choose "Status", then vibrating the flap switch (refer to 2.9 Device select) will display current position

Flap System	
Elevator	Normal
	Normal 0%
	Midpoint 0%
	Land 0%
Flap	Normal U100%
	Midpoint 0%
	Land D100%

Display present mode position

(4) Auto land

(4.1) Throttle stick setting

Press UP or DN to make the navigation mark to choose "Throttle stick" item, and press R or L to change value or Inhibit. It is possible to set the position when changing the value. The default setting is "Inhibit", and adjustable range is from 0.0 to 100.0%.

Flap System	
	Normal
Throttle Stick	Inhibit
Flight Mode 0	Switch
Flight Mode 1	Switch
Flight Mode 2	Switch
Flight Mode 3	Switch
Flight Mode 4	Switch

(4.2) Flight mode 0 setting

It is possible to set a certain flight mode switch automatically after automatic land. When do this, you must come to "Wing type" setting interface under the Model Menu and make correspond Wing type setting. Refer to 2.11 Wing type.

Press UP or DN to make the navigation mark to choose "Flight mode 0" item, and press R or L to 3 options : 0:Normal;1:Midpoint and 2:Land. It is Manual control when choose "Switch", but Automatic control when choose Flight mode switch position.

Flap System	
	Normal
Throttle Stick	Inhibit
Flight Mode 0	Switch
Flight Mode 1	Switch
Flight Mode 2	Switch
Flight Mode 3	Switch
Flight Mode 4	Switch

(4.3) Flight mode 1 setting: refer to "(4.2)Flight mode 0 setting"

(4.4) Flight mode 2 setting: refer to "(4.2)Flight mode 0 setting"

(4.5) Flight mode 3 setting: refer to "(4.2)Flight mode 0 setting"

(4.6) Flight mode 4 setting: refer to "(4.2)Flight mode 0 setting"

Press EXT to exit after finished.

3.15 Aileron to Flap Mix

The function aims at mixing flap when operating aileron stick, and can set switch. The flap dual channels should also be previously activated at Wing Type in Mode Menu (refer to "2.11 Wing Type")

Setting method

Press ENT to enter Main Menu, press UP or DN to make the navigation mark to choose "Function Menu", press ENT to enter Function Menu. Press UP or DN to choose "Aileron to Flap Mix" and then ENT to enter its setting interface.

Aileron to Flap Mix	
Pos 0	
Left	0%
Right	0%
Pos 1	
Left	0%
Right	0%
Throttle Stick	Inhibit
Switch	Pos 0

(1) Pos 0 to left setting

Press UP or DN to make navigation mark to select "Pos 0 to left setting", press R or L to change the leftward mix value of Aileron to Flap, the mix direction will be revised by changing the sign of plus or minus before the value, the adjustable range is ±125%.

(2) Pos 0 to right setting

press UP or DN to make navigation mark to select "Pos 0 to right setting", press R or L to change the rightward mix value of Aileron to Flap, the mix direction will be revised by changing the sign of plus or minus before the value, the adjustable range is ±125%.

(3) Pos 1 to left setting: refer above "(1) pos 0 to left setting"

(4) Pos 1 to right setting: refer above "(2) pos 0 to right setting"

(5) Throttle stick setting

The switch between Pos 0 and Pos 1 can be realized by setting the position of throttle stick. Press UP or DN to make navigation mark select "throttle stick setting", press R or L to change the value or inhibit. Change value can set throttle stick position. The default setting is "inhibit". The adjustable range is from 0.0% to 100.0%

(6) Switch setting

The switch will display the current switch position. Press UP or DN to choose Switch, press ENT to enter

interface of Switch selection, press UP or DN to choose desired item. Press ENT to confirm, the desired item whose left side will be changed into "1" from "0". If two or more items are selected, the item And should be selected, whose left side should be changed into "1" from "0". Press EXT after finished it.

Aileron to Flap Mix	
Pos 0	
Left	0%
Right	0%
Pos 1	
Left	0%
Right	0%
Throttle Stick	Inhibit
Switch	Pos 0

Switch	
⊙ And	
⊙ Flight Mode 0	
⊙ FMOD 1	
⊙ FMOD 2	
⊙ Flight Mode 3	
⊙ Flight Mode 4	
⊙ Flap Normal	
⊙ Flap Midpoint	

3.16 Pitch Curve

Pitch Curve can be adjusted via seven points. Pitch Curves of Pos 0 and Pos 1 can be set, respectively. The item Pitch should be previously set in Device Output at Model Menu (Refer to "2.10 Device Output").

Setting method:

Press ENT to enter Main Menu, Press UP or DN to move navigation mark to select Function Menu. Press ENT to enter Function Menu, Press UP or DN to select Pitch Curve, Press ENT to enter Pitch Curve interface. A

dropdown menu with "All Servos Hold?" will pop up. select Ok for locking all the current statuses of servos, and select Cancel for unlocking the current statuses. And the interface will show the current used channel and the current position statuses of switches.

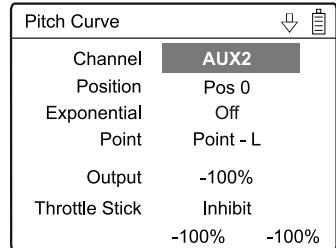
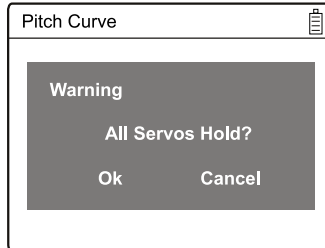

(1) Channel: this item will show that the channel Pitch has been set.

(2) Position selection

Press UP or DN in the "Pitch Curve" setting interface to select "Position", press R or L to select the item you want to set in the list with Pos 0 and Pos 1.

(3) Exponential setting

Press UP or DN in the "Pitch Curve" setting interface to select "Exponential" setting, press R or L and there are two options: Off and On. If you want to make the curve have a smooth change, choose On; if not, choose Off.

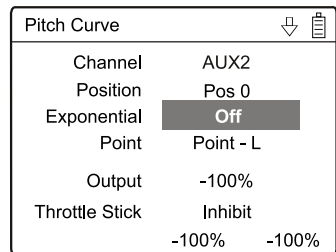

(4) Curve setting

Including "Point" and "Output".

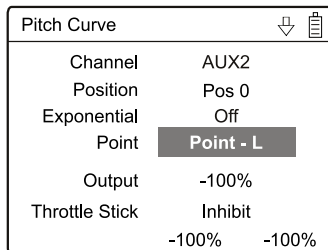

(4.1) Point setting

Press UP or DN in Pitch Curve interface to select Points setting. Press R to expand a list including seven points: "Point-L", "Point-1", "Point-2", "Point-M", "Point-3", "Point-4" and "Point-H". Press R or L to select the point you want to adjust.

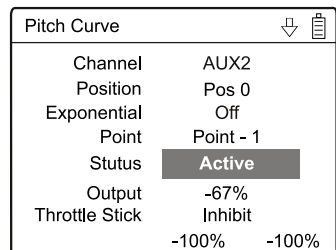

(4.2) Status setting

Press UP or DN to move navigation mark to Status and press R or L to choose Inhibit or Active. Select Inhibit if keeping the current value(the default setting is Inhibit). Select Active for changing the above points' value.

Note: After select point -L or Point-H, the status setting won't be display.

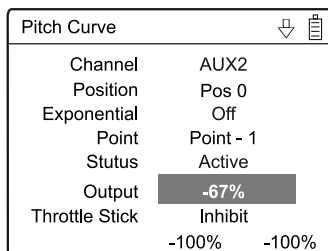

(4.3) Output setting

There is a expand item "Output" after select Status Active, press UP or DN to select Output setting, press R or L to increase or decrease, respectively, the output value. The adjustable range is ±100%.

(5) Throttle Stick setting

The switch between Pos 1 and Pos 0 can be freely realized through throttle stick after the below amount has been set up. The below set amount is the position of throttle stick as well as the switch point.

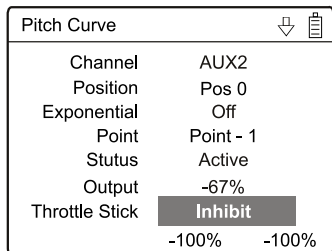

Throttle Stick setting: Press UP or DN to select Throttle Stick setting, Press R or L to increase or decrease, respectively. The adjustable range is from 0.0% to 100.0%. Choose Inhibit and the throttle stick will not be set as a switch.

(6) Switch Selection

When the item Throttle Stick is set in Inhibit, it is possible to switch between Pos 0 and Pos 1 by Switch. Press UP or DN to select "Switch". Press ENT to enter Switch interface, press UP or DN to choose desired item. Press ENT to confirm, the desired item whose left side will be changed into "1" from "0". If two or more items are selected, the item And should be selected, whose left side should be changed into "1" from "0". Press EXT after finished it.

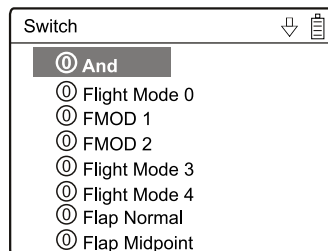
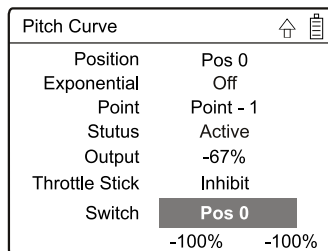

3.17 Program mix

There are 8 series of program mix, mix channels and values are adjustable.

Setting Method:

Press ENT enter to Main Menu. Press UP or DN select function, press ENT to enter function menu, then press UP or DN select "Program Mix". And press ENT to program Mix setting and current status (default setting is "Inhibit") interface. Press R or L to choose Inhibit, Normal or Curve.

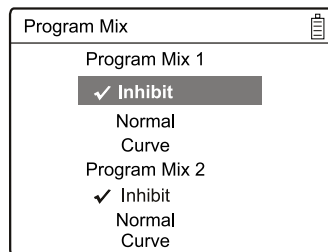

Take "program mix 1" for example, there are "Normal" and "Curve" setting.

(1) The "Normal" setting of "program mix"

Press UP or DN select the "Normal" setting, Press ENT button then pop up "All Servos Hold?" Press R or L to choose OK or Cancel. If "OK" selected, all the servos will be locked in the current status, if "Cancel" selected, all servos are unlocked. Press ENT enter to Program Mix 1 setting interface.

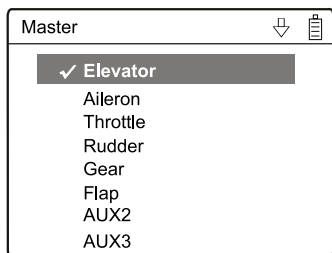
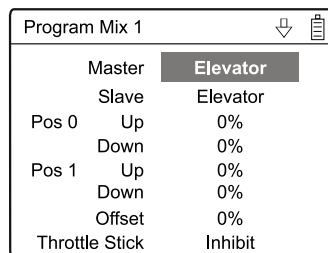
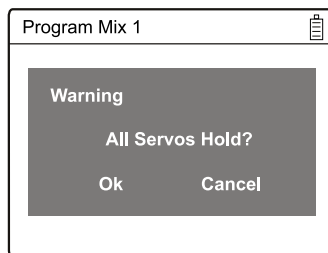

(1.1) Master channel setting

Press UP or DN to move the navigational mark to select Master option and press ENT to Master interface. Press UP or DN to select the desired channel and press ENT to make a "✓". Press EXT to be back to Program Mix 1 interface.

(2) Slave channel setting

Press UP or DN to move the navigational mark to select Slave option and press ENT to Slave interface. Press UP or DN to select the desired channel and press ENT to make a “√”. Press EXT to be back to Program Mix1 interface.

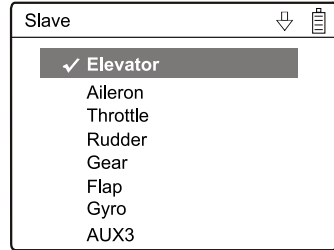

(1.3) Gain setting: Take Elevator at Master as an example.

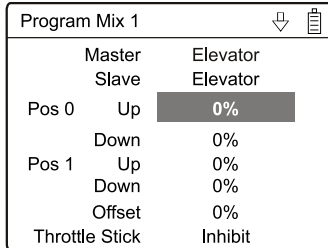

(1.3.1) Pos 0 UP:

Mix amount setting when elevator stick moved upward.

Press UP or DN to move the navigational mark to select "Pos 0 Up" item. Press R or L to increase or decrease, separately, the mix amount. It is possible to reverse mix direction through changing the plus or minus sign before amount. The adjustable range is ±125%.

(1.3.2) Pos 0 Down:

Mix amount setting when elevator stick moved downward.

Press UP or DN to move the navigational mark to select "Pos 0 Down" item. Press R or L to increase or decrease, separately, the mix amount. It is possible to reverse mix direction through changing the plus or minus sign before amount. The adjustable range is ±125%.

(1.3.3) Pos 1 Up setting method refer to (1.3.1) Pos 0 Up setting.

(1.3.4) Pos 1 Down setting method refer to (1.3.2) Pos 0 Down setting.

(1.3.5) Offset Setting

This function can make Slave begin to mix through the corresponding Lever switch from a certain point as the starting point.

Press UP or DN to move the navigational mark to select "Offset" item. Press R or L to increase or decrease, separately, the mix amount. It is possible to reverse Offset direction through changing the plus or minus sign before amount. The adjustable range is ±100%.

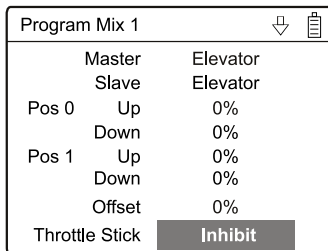
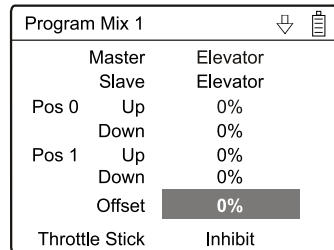

(1.4) Throtte Stick

The switch between Pos 0 and Pos 1 can be realized by setting the position of throttle stick. Press UP or DN to make navigation mark to select "throttle stick" setting, press R or L to change the value or inhibit. Change value can set throttle stick postion.The default setting is “inhabit”. The adjustable range is from 0.0% to 100.0%

(1.5) Switch Selection

When the item Throttle Stick is set in Inhibit, it is possible to switch between Pos 0 and Pos 1 by Switch. Press UP or DN to select “Switch”. Press ENT to enter Switch interface, press UP or DN to choose desired

item. Press ENT to confirm, the desired item whose left side will be changed into “1” from “0”. If two or more items are selected, the item And should be selected, whose left side should be changed into “1” from “0”. Press EXT after finished it.

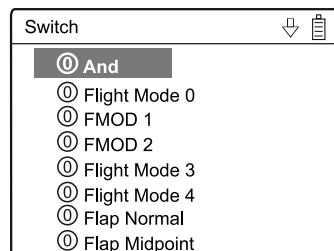
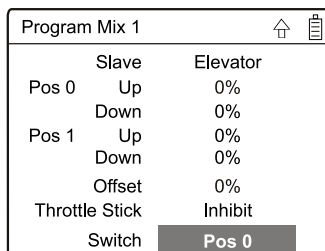

(2) Setting Method for Curve in Program Mix1

In the Program Mix interface, press UP or DN to select Curve, press ENT to confirm. Then the interface pop up "All Servos Hold?", press R or L to choose OK or Cancel. If select OK, all the servos will be locked in the current status, if select Cancel, all servos are unlocked. Press ENT to setting interface of program Mix1 and it will show the setting item.

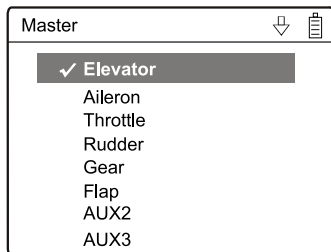
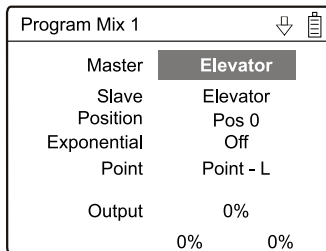
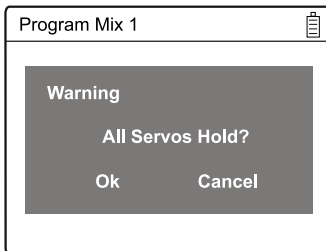

(2.1) Master channel setting

Press UP or DN to move the navigational mark to select Master option and press ENT to Master interface. Press UP or DN to select the desired channel and press ENT to make a "✓". Press EXT to be back to Program Mix 1 interface.

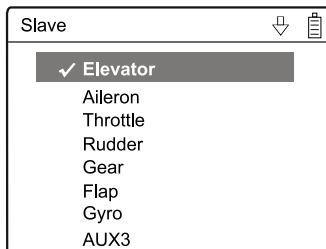

(2.2) Slave channel setting

Press UP or DN to move the navigational mark to select Slave option and press ENT to Slave interface. Press UP or DN to select the desired channel and press ENT to make a "✓". Press EXT to be back to Program Mix1 interface.

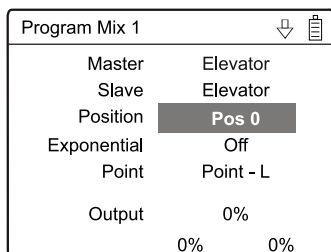

(2.3) Position

There have two options: Pos 0 and Pos 1. Press UP or DN to move the navigational mark to select the "position", press R or L to select "Pos 0" or "Pos 1" .

(2.4) Exponential Curve

Press UP or DN to choose the setting item of "Exponential" .There are On or Off option when you press the R or L buttons. Select On for smooth changes, and Off for changes in the form of fold ling in Exponential curve, respectively.

(2.5) Point Setting

Press UP or DN to move the navigation mark of Point option. Press R or L, there are 7 piont options including "Point-L", "Point-1", "Point-2", "Point-M", "Point-3", "Point -4" and "Point-H". Select the point you want to set.

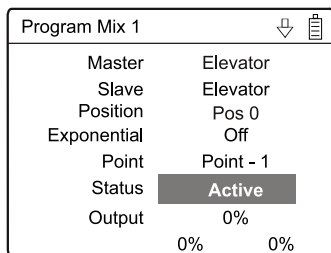
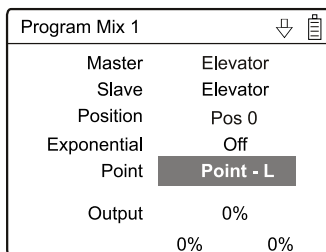

(2.6) Status setting

(There is no Status options when the piont is Point-L or Point-H) After selecting the point that you want to set, press UP or DN to move the navigational mark to Status item. Press R or L, there are two options of Inhibit and Active. Select Inhibit for unchanging the current amount (the default setting is Inhibit).

(2.7) output setting

When the Status option is Active, the Output option will be listed. Press UP or DN to move the navigational mark to Output. Press R or L to increase or decrease, respectively, the output amount. It is possible to reverse the mix direction by changing the plus or minus sign before the amount. The adjustable range is $\pm 100\%$.

Program Mix 1	
Master	Elevator
Slave	Elevator
Position	Pos 0
Exponential	Off
Point	Point - 1
Status	Active
Output	0%
	0%

Program Mix 1	
Position	Pos 0
Exponential	Off
Point	Point - 1
Status	Active
Output	0%
Throttle Stick	Inhibit
Switch	Pos 0
	0%
	0%

(2.8) Throtte Stick

The switch between Pos 0 and Pos 1 can be realized by setting the position of throttle stick. Press UP or DN to make navigation mark to select "throttle stick" setting, press R or L to change the value or inhibit. Change value can set throttle stick position. The default setting is "inhibit". The adjustable range is from 0.0% to 100.0%

(2.9) Switch Selection

When the item Throttle Stick is set in Inhibit, it is possible to switch between Pos 0 and Pos 1 by Switch. Press UP or DN to select "Switch". Press ENT to enter Switch interface, press UP or DN to choose desired item. Press ENT to confirm, the desired item whose left side will be changed into "1" from "0". If two or more items are selected, the item And should be selected, whose left side should be changed into "1" from "0". Press EXT after finished it.

Program Mix 1	
Position	Pos 0
Exponential	Off
Point	Point - 1
Status	Active
Output	0%
Throttle Stick	Inhibit
Switch	Pos 0
	0%
	0%

Switch	
ⓐ	And
ⓑ	Flight Mode 0
ⓒ	FMOD 1
ⓓ	FMOD 2
ⓔ	Flight Mode 3
ⓕ	Flight Mode 4
ⓖ	Flap Normal
ⓗ	Flap Midpoint

3.18 Monitor

This function can display the current status and positions of all the channels' outputs, and check the current working status of each channel.

Monitor			
Elevator	0	Gyro	0
Aileron R	1	AUX3	-100
Throttle L	100	AUX4	-100
Rudder R	34	AUX5	-100
Gear	-100	AUX6	+100
Flap D	100	AUX7	+12

Press ENT to enter Main Menu, and then press UP or DN to move the navigational mark to select Function Menu. Press ENT to enter the Function Menu and then press UP or DN to select servo Monitor and press ENT to enter the monitor interface for checking the current working status of each channel. Press EXT to exit .

3.19 Fail safe

There are two possibilities for use if the transmission signal is under abnormal condition. The first one is to lock the last action data received; the second one is to execute the pre-set data which is pre-set. The default setting is Servo Hold.

Setting method:

Press ENT to enter the Main Menu, and then press UP or DN to move the navigational mark to select Function Menu. Press ENT to enter the Function Menu then press UP or DN to select Fail Safe and press ENT to enter the Fail Safe interface. Take the item Elevator as an example to explain.

Fail Safe	
Elevator	Servo Hold
Aileron	Servo Hold
Throttle	Servo Hold
Rudder	Servo Hold

Press UP or DN to select Elevator on the Fail Safe interface, then press R or L to change the status of Servo Hold into Fail Safe (If you want to keep Servo hold status, there is no need to re-set). There is an expanded sub-item blow. Press UP or DN to select 0%, then press R or L to increase or decrease, respectively, the position amount which centers on the neutral point of servo. The available value is 125%, respectively. 0% is the neutral point of servo.

The setting methods for other channels are same as above.

Press EXT to exit after finished.

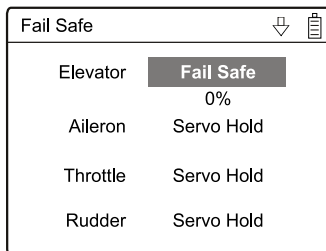

Note: checking whether all the actions when fail safe happened are correct, is a must after the setting is finished. It is dangerous to use full throttle, especially after fail safe taken place.

3.20 Sensor View

Setting method: Press ENT to enter the Main Menu and press UP or DN to move the navigational mark to

select Function Menu. Then press ENT to enter the Function Menu and press UP or DN to select Sensor View, then press ENT to enter the Sensor View interface, like below pictures. If all the sensors disconnect, telemetry signal lost, there will be inhibits shown on the view. If all work normal, all the measured data will be shown.

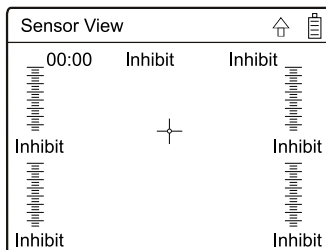
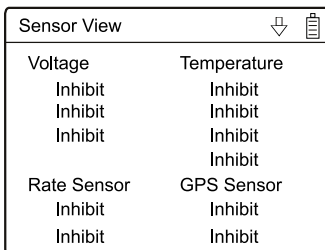

- (1) Voltage: Show 3 different measured voltage value;
- (2) Temperature: Show 4 different measured temperature value;
- (3) Rate Sensor: Show 2 different measured RPM value;
- (4) GPS image display: in the interface of Sensor View, press DN to go to GPS image display. It will show: local time, longitude, latitude, altitude, move speed, and battery Volume. If you set the image as the background, these informations will be seen from the image.

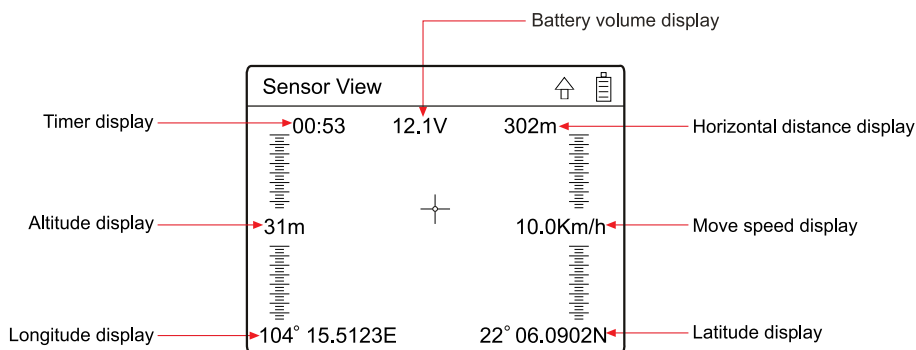
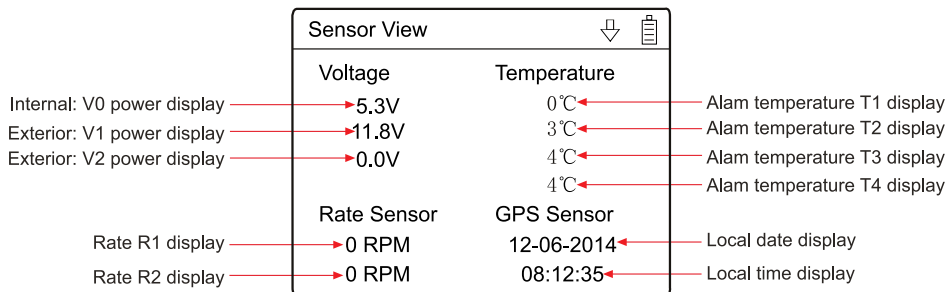

3.21 Trainer

Two DEVO F12E transmitters working together can execute the training function to meet the requirements for the beginner. The setting method is shown as below:

(1) Data copy

First, use the wireless copy function between two DEVO F12E to copy the main transmitter's model data to the trainee's transmitter, this promise the model data between two transmitters is same. Refer the copy method to the second part of helicopter "2.4 model wireless copy" and do the following steps:

(2) Linkage

Insert the digital signal wire from the trainer's transmitter into the DSC socket of the trainee's transmitter. Turn on the transmitter and a linkage icon will be shown on the boot screen.

linkage icon

Turn on the power of the trainer's radio. Find out the trainee's model data, and then let the trainer's Radio bind with the aircraft model and fly it normally. Then turn off the power. Insert the other end of the digital signal wire into the trainer's DEVO F12E, and then turn on its power. A linkage icon will be shown as below:

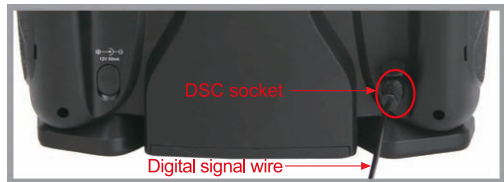
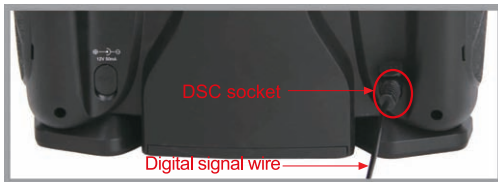
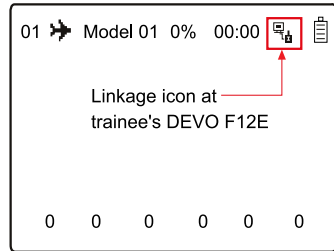

Trainer icon

Training status display: when the trainer's icon becomes into "X", the trainee stops flying and the trainer is working; when the trainer's icon turns into "✓", the trainee is flying and the trainer is in leisure.

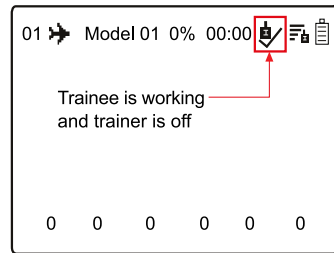
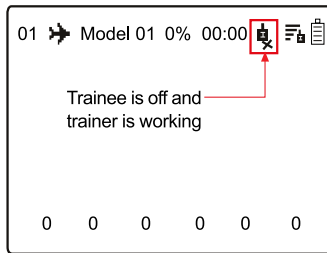

(3) Usage method

The training switch can be freely switchable between left trim and right trim. The default setting is right trim, see as the right illustration.

During flight, if the trainer pushes Right Trim once, the linkage icon will be shown as "✓" that means the control right is moved to the trainee from Trainer. If trainer pushes Right Trim once again, the linkage icon will be shown as "X" that means the trainer takes back the control right from the trainee.

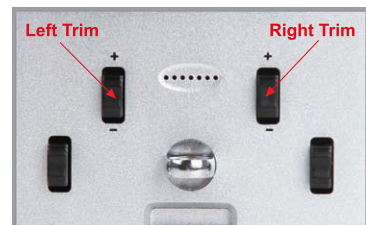

(4) Setting for training function channels

Trainee is available to get full or part of flight control power to the aircraft model via setting the training function channel in the trainer's radio. Below is the setting method:

Trainer	
Switch	Right Trim
Elevator	Inhibit
Aileron	Inhibit
Throttle	Inhibit
Rudder	Inhibit
Gear	Inhibit
Flap	Inhibit
Gyro	Inhibit

Press the ENT to enter Main Menu, and then press UP or DN to move the navigational mark to select Function Menu. Then press ENT to enter the Function Menu and press UP or DN to select "Trainer", then press ENT to enter the Trainer interface. The available channels are shown as left illustration, and the current status of trainer switch is also shown there.

Trainer switch selection: Press UP or DN to select the switch option; press R or L to select the switch which you want. It includes right and left trim. The default setting is Right trim.

Channel selection: Press UP or DN to select the channel option; Press R or L to select the channel(s) which you want to grant to trainee. The channel(s) you have selected will be activated as "Active". The channels which are not granted to trainee will be kept inhibited. The default setting is "Inhibit".

Press EXT to exit.

3.22 Timer

There are two timers which can be set as stopwatch and countdown, respectively. Each timer can be operated by switch or by shortcut.

Setting method:

Press ENT to enter Main Menu, and then press UP or DN to move the navigational mark to select Function Menu. Then press ENT to enter the Function Menu and press UP or DN to select "Timer", then press ENT to enter Timer interface. The timing range of stopwatch is from 00:00 to 59:59 (59 minutes 59 seconds). The default setting is stopwatch.

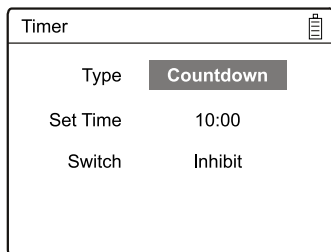
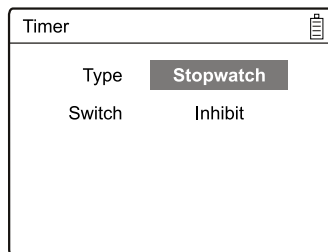

(1) Countdown setting

If you need countdown time manner, press R or L to select the countdown. There is an expand sub-menu set time item. Press UP or DN to move the navigational mark to select the option of Setting time item. Press R or L to set the countdown time. The settable countdown time range is from 00:10 to 59:50.

(2) Switch selection

Press UP or DN to move the navigational mark to Switch. There are Inhibit and available switch options, available switch can be selected by press L or R. It includes FMOD1,2, FMOD2, MIX1,2, MIX2, ELEV D/R, AILE D/R, RUDD D/R, GEAR SW, SPS0 SW, SPS1 SW, SPS2 SW and SPS3 SW. We can select the desired item except these items of SPS0 SW, SPS1 SW, SPS2, and SPS3 which should be previously set at Stick Position Switch at Model Menu (refer to "2.8 Stick Position Switch").

Press EXT to exit after finished.

(3) Usage of timer

Press UP or DN in main panel. It's possible to start Timers by pressing UP key for one time, and to pause it by pressing it the second time. Press DN to clear timer. It's ok to control time by Switch when time setting is finished on switch. Timer will be shown in main interface, as right illustration:

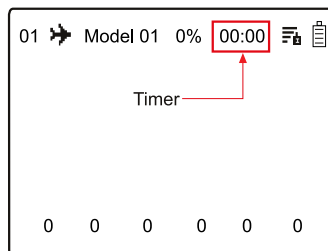

devention

DEVO F12E

Part four

Glider

All the functional settings, which are relative to the operation system of DEVO F12E itself, are fully integrated in System Menu. They include Language, Display, Buzzer, vibrator, Video Setting, Stick Mode, Stick Direction, Stick calibration, Battery and About.

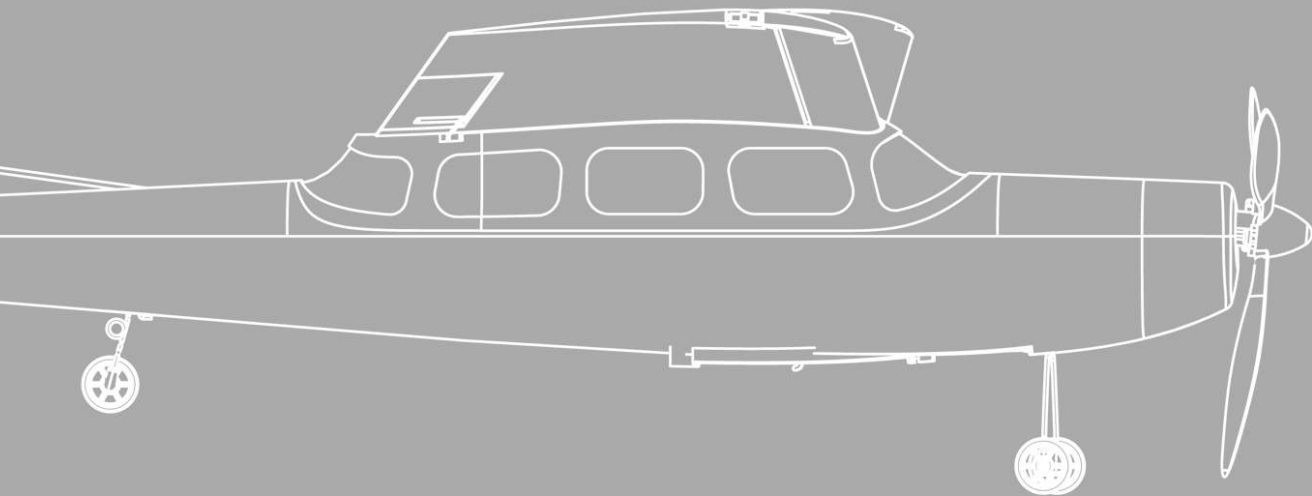

1.0 System Menu

All the functional settings, which are relative to the operation system of DEVO F12E itself, are fully integrated in System Menu. They include Language, Display, Buzzer, Vibrator, Video Setting, Stick Mode, Stick Direction, Stick calibration, Battery and About.

Below is the boot screen of Glider(e.g Spoiler stick on the right):

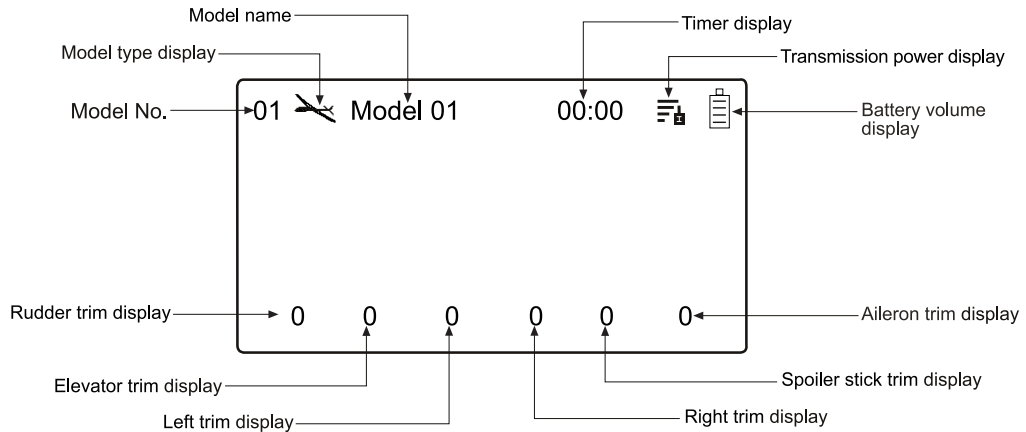

1.1 Language setting

Press ENT to the Main Menu, press UP or DN to select System Menu, then press ENT to System Menu.

Press UP or DN to select "Language" and press ENT to the Language setting interface. Press UP or DN to select the language that you want. A "✓" will be shown on the screen after selected. Press EXT to exit.

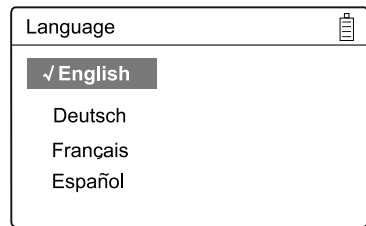

1.2 Display

Press ENT to the Main Menu, press UP or DN to select System Menu, then press ENT to System Menu. Press UP or DN to select "Display" and press ENT to the Display setting interface. Press UP or DN to select the needed setting and press R or L set.

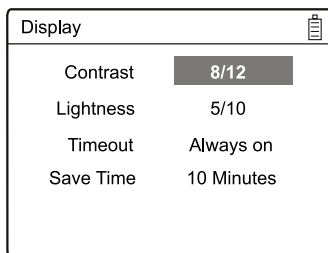

Three items are available to be set. Below are the setting methods for them:

- (1) Backlight contrast: the backlight contrast is adjustable by pushing UP or DN to move the navigational mark to the digits after Contrast. Press R key to increase the backlight contrast, while press L to decrease it.
- (2) Backlight lightness: the backlight lightness is adjustable by pressing UP or DN to move the navigational mark the digits after Lightness. The power consumption will be increased if the backlight lightness is too bright and the battery cruise duration will be shortened. Press R or L to increase or decrease the lightness. When the value is one means turn off the backlight.
- (3) Backlight timeout: it is possible to set the duration which LCD stays at highlight in the form of "Always on" or any period from 5 to 60 seconds with an interval of 5 seconds. Press UP or DN to move the navigational mark to select the digits after Timeout. Press L to short the time of backlight duration or keep it in the form of "Always on" while push R or prolong the time. The maximum is 60s.

(4) Save Time: the Save time setting can set extinguish time when there is no operation on screen, can save the power, and extend the using time of the battery, can also set as always lighting.

Press UP or DN to select the number behind the Save time, Press R can make the always lighting longer, the longest time is 30mins; Press L can reduce the always lighting time or always open. Press EXT to exit.

1.3 Buzzer warning

Press ENT to the Main Menu, press UP or DN to select System Menu, then press ENT to System Menu. Press UP or DN to select "Buzzer" and press ENT to the Buzzer setting interface. Press UP or DN to select the needed setting and press R or L set.

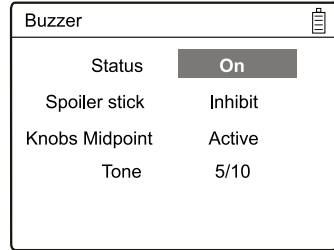

- (1) Status: there are On and off two status on the Buzzer interface. Pressing UP or DN to move the navigational mark to the status option. Pressing R or L to change the On or Off status. It includes Spoiler stick, knobs Midpoint and Tone items under the status is On.
- (2) Spoiler stick buzzer: Press UP or DN to move the navigational mark to Spoiler Stick item then press R or L to change the status from Inhibit to Active. When Buzzer is at the status of On, if Spoiler Stick is set as "Active", there is buzzer sound when you push the Spoiler stick to the midpoint. If you don't need the buzzer sound, please change the status to Inhibit.
- (3) Knobs midpoint Buzzer: When Buzzer is at the status of On, if Knobs is set as "Active", there is buzzer sound when you turn the AUX4 and AUX5 to the midpoint. If you don't need the buzzer sound, please change the status to Inhibit.
- (4) Buzzer tone: the tone is composed of 10 grades. You can choose the favorite one according to your interests. Press UP or DN to move the navigational mark to Tone item and press R or L to make a listening test. Press EXT to exit.

1.4 Vibrator

The vibrator used as an alarm function to remind the users.

Press ENT to get the Main Menu, press UP or DN to select System Menu. And then press ENT to get System Menu, press UP or DN to select Vibrator. Press ENT to get Vibrator setting interface. There are two status as Inhibit and Active. Press R or L to select Active if need. Press EXT to exit after finished.

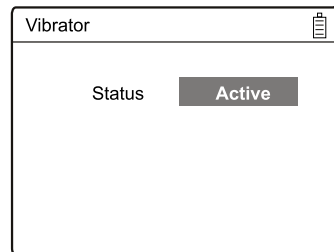
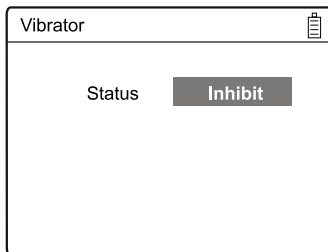

1.5 Video Setting

Press ENT to get the Main Menu, press UP or DN to select System Menu. And then press ENT to get System Menu, press UP or DN to select Video Setting. Press ENT to get Video setting interface. Press R or L to select Inhibit or Active.

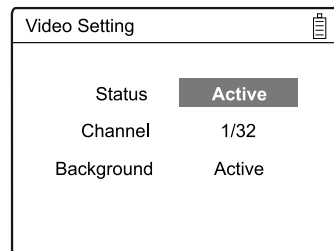
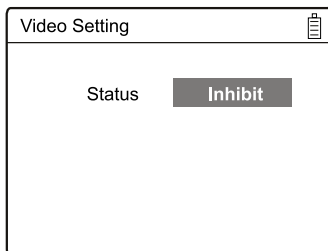

- (1) Status Selection: choose Inhibit to inhibit video show; choose Active to active video show and the interface will extend 32 channels for selection.
- (2) Channel Selection: choose the corresponding channel of 5.8G transmitter module then the background will show the image which it receives.
- (3) Background: there are two selections Inhibit and Active. Choose Active to show the image in the main interface as the background. Press EXT to return main interface after having finished the settings. In the main interface, press EXT to enjoy the full screen display.

1.6 Stick Mode

Press ENT to get Main Menu, press UP or DN to select System Menu, and then press ENT to the System Menu, press UP or DN to select Stick Mode, and press ENT to get stick Mode setting interface.

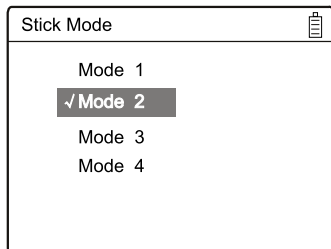

MODE 2 and MODE 4 are listed in left-hand Spoiler.

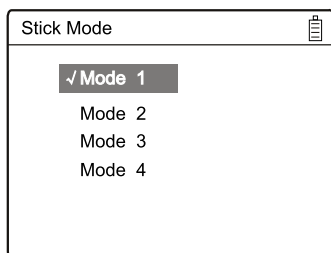
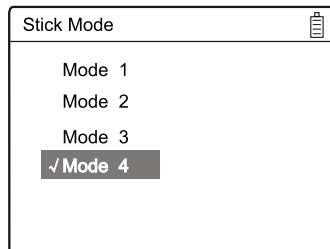

MODE 1 and MODE3 are listed in right-hand Spoiler.

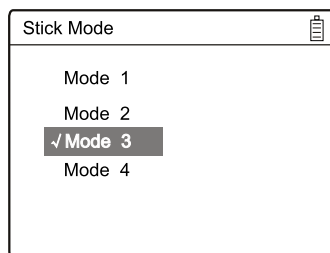

Select the stick mode according to the spoiler mode showing on the screen. DEVO F12E offers 4 stick modes, please refer to "8.0 Switches exchange between left-hand and right-hand spoiler. Press EXT to exit after finished.

1.7 Stick Direction

Press ENT to get Main Menu, press UP or DN to select System Menu, and then press ENT to the System Menu, press UP or DN to select Stick Direction, and press ENT to get stick direction setting interface.

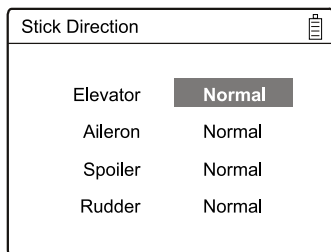

Stick Direction: There are four items available as Elevator, Aileron, Spoiler and Rudder. Press UP or DN to select the stick which will change direction, and press R or L to change the direction. The factory setting is Normal.

1.8 Stick Calibration

It is a function to re-calibration when stick unusual.

Calibration method:

Press "ENT" to the Main Menu, press UP or DN to select System Menu, then press ENT to System Menu. Press UP or DN to select Stick Calibration and press ENT to the Stick Calibration setting interface.

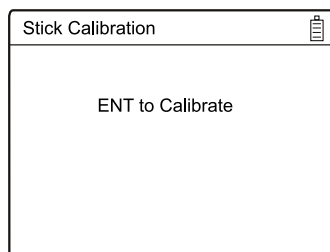

Press ENT button to enter the calibration, Repeat to shark the left and right of the remote control sticks from the rock bottom to highest respectively for several times and then back to the rocker. Press ENT to confirm , if your action is wrong, will display "please Retry!" ; If correct, display "calibration success!" . And then press EXT exit.

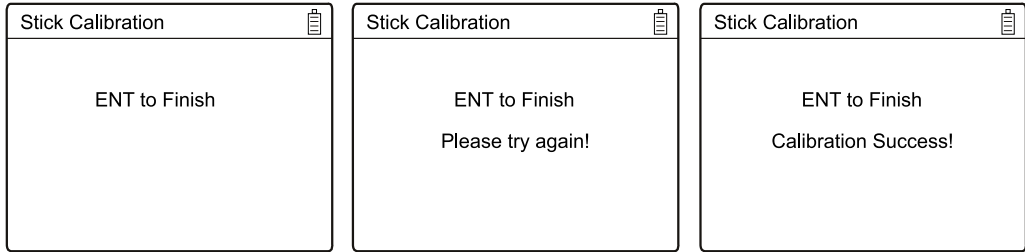

1.9 Battery

Battery voltage can set up the warning value for radio battery in lower voltage.

Press ENT to the Main Menu, press UP or DN to select System Menu, then press ENT to System Menu. Press UP or DN to select "Battery" and press ENT to the Battery setting interface. Warning voltage value can be changeable by R or L button.

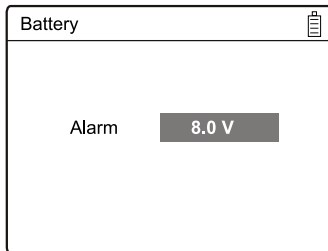

Low Voltage Warning: Please set up the low voltage warning value when you turn it on following the battery specification.

Battery voltage	Li-Po battery 7.4V	Li-Po battery 11.1V	Dry battery 8x1.5V
Advised warning voltage	6.4V	9.6V	8.0V

1.10 About

Press "ENT" to the Main Menu, press UP or DN to select System Menu, then press ENT to System Menu. Press UP or DN to select About and press ENT to the About setting interface.

Press EXT to exit after finished.

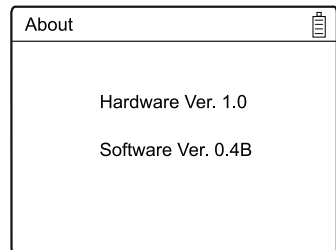

2.0 Model Menu

Model Menu manages all the model data saved in DEVO F12E. It includes Model Select, Model Name, Model Copy, Model Transmit, Model Receive, Model Reset, Type Select, Trim System, Stick Position Switch, Device Select, Device Output, Wing Type, Power Amplifier, Fixed ID and Sensor setting.

2.1 Model Select

Press ENT to enter Main Menu and press UP or DN to make Model Menu is selected. Press ENT to get the Model Menu and press UP or DN to select Model select, press ENT to enter the Model Select setting interface.

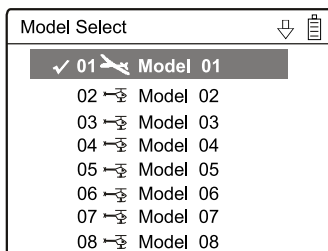

Press UP or DN to select the model you desired, press ENT to confirm and marks "✓" in the front of selected one. Total 15 models are optional, used to save the model data. Press EXT to exit after finished.

2.2 Model Name

In the menu of model name, you can make a desired name for your model for long term storage. Its data can be directly withdrawn in next flights. Repeat the step "2.1 Model Select" to choose the model you want to name or save, press EXT to back to the interface.

Press "ENT" to enter Main Menu, press UP or DN to select "MODEL Menu", then Press "ENT" to enter Model Menu; Press UP or DN to select "Model NAME" and then press "ENT" button to enter the "Model Name" setting interface.

Press UP or DN to select the character and figure which are needed to be changed, press R or L button to change the character and figure, and press UP or DN to set next one. Press EXT to exit after finished.

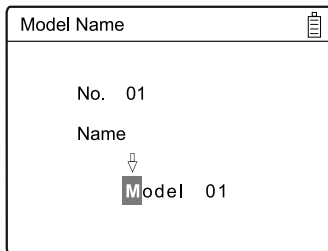

2.3 Model Copy

Press ENT to enter "Main Menu" and press UP or DN to make "Model Menu" is selected. Press ENT to enter "Model Menu" and press UP or DN to select "Model Copy", press ENT to the "Model Copy" setting interface as picture (1).

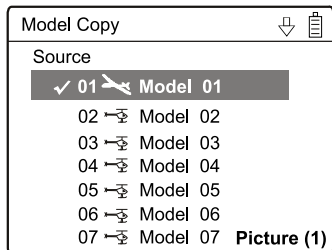

Press UP or DN to choose the source of model copy, press ENT to confirm then you can see the Destination selection as picture (2).

Press UP or DN to choose the destination of model copy, press ENT to confirm then you can see the ask interface as picture (3). Press ENT to execute the operation and return to model menu. Press EXT to exit if not need to execute the operation.

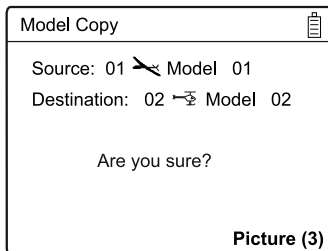
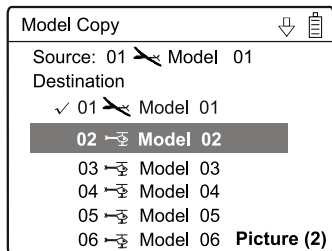

2.4 Model wireless copy

The model data between two DEVO F12E equipments can be wirelessly copied via Model Transmit and Model Receive in Model Menu.

(1) Model transmission

Press ENT to enter "Main Menu" and press UP or DN to select "Model Menu". Press ENT to enter "Model Menu" and press UP or DN to select "Model transmission", continue to press ENT to enter "Model Transmit" setting interface.

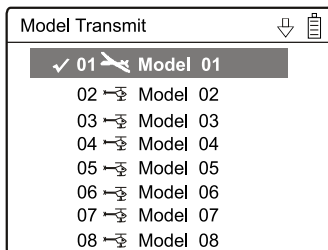
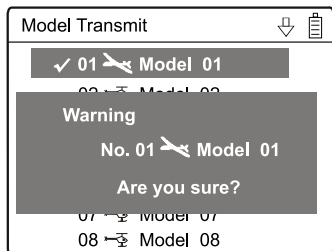

Press UP or DN to choose the source model which will be transmitted, and press ENT to confirm, an enquiry information "Are you sure?" will be shown as left Illustration.

Welcome to use the DEVO F12E transmitter

Press ENT to transmit, "Transmitting" appears in the interface. Or press EXT to exit. Press EXT to exit after another DEVO F12E received the data.

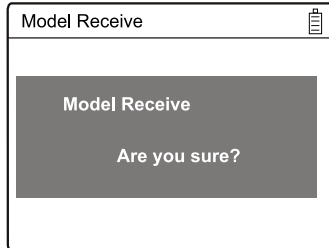

(2) Model receiving

Press ENT to enter Main Menu and press UP or DN to select Model Menu. Press ENT to get Model Menu and press UP or DN to select Model Receiving, continue to press ENT to enter Model Receive setting interface. An enquiry information "Are you sure?" will be shown as left Illustration.

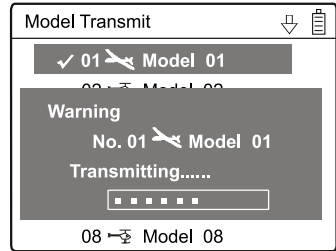

Press ENT to receive, "Connecting" and "Receiving" will be shown in series in the interface. The information of "Received" with the model name will be shown after receiving is finished. Or press EXT to exit.

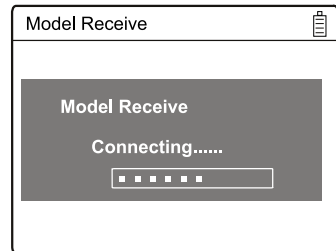

Press UP or DN to choose the save position, an enquiry information "Are you sure?" is shown after press ENT. Press ENT to save or press EXT to exit.

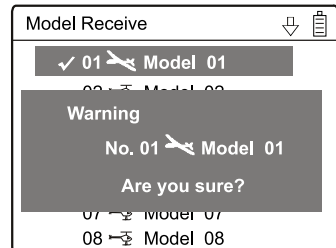
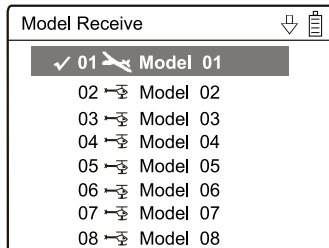

2.5 Model reset

All the model data can be restored to factory settings via Model Reset.

Press the ENT to enter Main Menu and press UP or DN to select Model Menu. Press ENT to get Model Menu and press UP or DN to select Model Reset, press ENT to enter Model Reset setting interface.

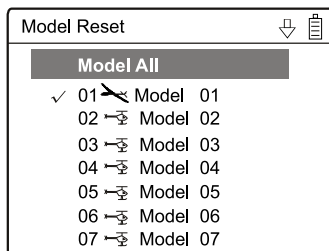

It is possible to store up to 15 models data in the model list of DEVO F12E equipment. There are two methods to reset the model data: batch reset and single reset.

Batch reset: press UP or DN to select Mode All, an enquiry information "Are you sure?" will be appears in the interface. Press ENT to reset all models, or press EXT to exit.

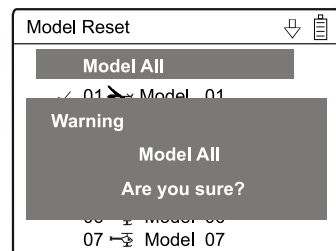

Single reset: Press UP or DN to choose the model you want to restore, “Are you sure?” will appear after press ENT. Press ENT to reset or press EXT to exit.

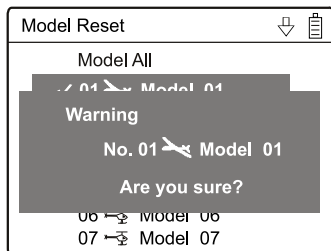

2.6 Type Select

This device offers three model types menu. They are Helicopter, Airplane and Glider respectively.

Press ENT to enter Main Menu and press UP or DN to select Model Menu. Press ENT to enter and press UP or DN to select Type Select and press ENT to enter setting interface.

Press “ENT” button to get Helicopter, Airplane and Glider selections and press UP or DN to select and press ENT to confirm, then press EXT to exit.

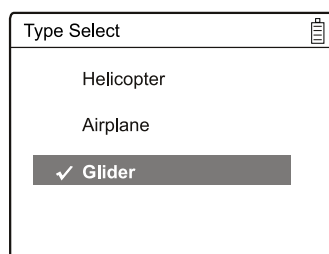

2.7 Trim System

Trim System is able to finely tune the following six items, respectively: Elevator, Aileron, Rudder, Spoiler, Left Trim and Right Trim. The trim range is divided into 20 grades (factory default is set at 4). It is convenient to subtly modify the pitch by adjusting the trim range.

Press ENT to enter Main Menu and press UP or DN to select Model Menu. Press ENT to enter and press UP or DN to select Trim System, press ENT to enter Trim System setting interface. Press UP or DN to select the trim which will set, press R to increase the trim value and press L to decrease.

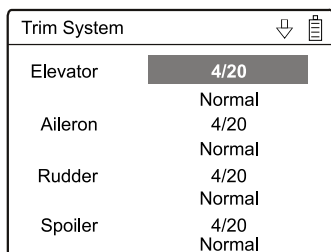

For elevator, aileron, and rudder, there are two more options: Normal and Limited, press R or L you can change the setup. “Normal” means the trim is always working although the corresponding stick stays anywhere. “Limited” means the trim is out of working when the corresponding stick is at maximum position.

Press EXT to exit after finished.

2.8 Stick Position Switch

According to the following setting, the switch can be used as a switch. The turn-on or turn-off position at which stick stays can also be settable.

Method for setting:

Press the ENT to enter Main Menu and press UP or DN to select Model Menu. Press ENT to get Model Menu and press UP or DN to select Stick Position Switch, press ENT to enter Stick Position Switch setting interface.

There are four options under the Stick position switch: SPS0, SPS1, SPS2, SPS3. Press R or L to choose the switch you want to define.

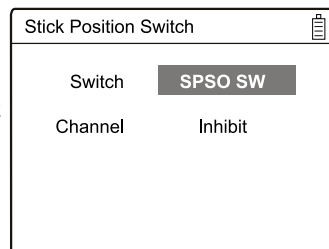

Press UP or DN to inhibit channel in navigation mark, and press R to expand the menu. The channel includes four items: Elevator, Aileron, Spoiler and Rudder. The factory default is Inhibit. Take Elevator for example.

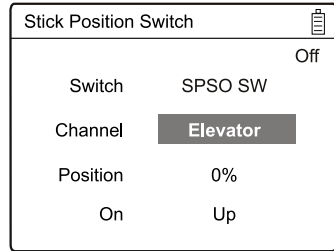
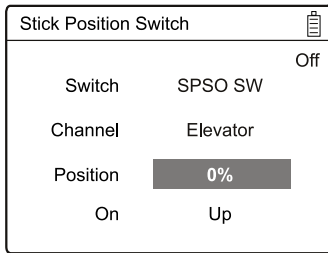

Press R or L to choose the Elevator as stick, then Press UP or DN to move navigation mark to value of position. It's possible to adjust the stick position via pressing R or L.

Press UP or DN to navigate the On setting, press R or L to change the direction of the channel stick.

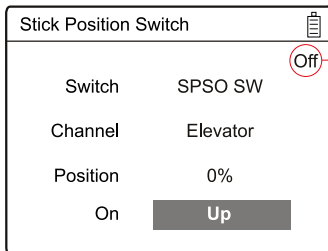

Display of stick position switch status

Moving the stick to make sure that the direction of stick's turn-on or turn-off position is correct.

After finished the setting, press EXT to exit.

2.9 Device select

This setting can help you configure various functional switches, or adjust levers. It includes Flight Speed Switch, Flight Launch Switch, Aileron and Rudder Trim, Flap Trim, Flaperon Trim.

Press ENT to enter Main Menu, press UP or DN to move navigation mark to select Model menu. Press ENT to enter Model menu. Press UP or DN to Device select Option. Press ENT to Device select Option interface.

(1) Flight Speed Switch:

Press UP or DN to move navigation mark to Flight Speed Switch and press R or L to select the desired switch. The factory default setting is Inhibit.

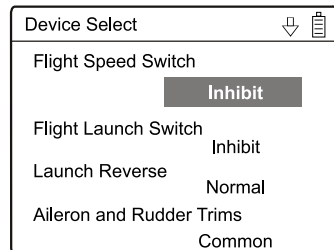

(2) Flight Launch Switch:

Press UP or DN to move navigation mark to Flight Launch Switch and press R or L to select the desired switch. The factory default setting is Inhibit.

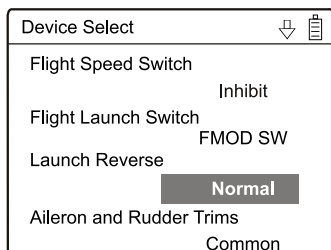

Launch Reverse: Press UP or DN to move navigational mark to "Launch Reverse" setting after you select the Flight Launch Switch, press R or L to Normal or Reverse. The factory default is Normal.

(3) Aileron and Rudder Trims

There are two options: Common and Flight Mode. In Common option, the adjustment parameter, of which the stick is corresponding to trim, puts an equal effect on all the flight modes.

In Flight Mode, the adjustment parameter, of which the stick is corresponding to trim, puts a respective effect on the corresponding flight mode. The factory default setting is Common.

Press UP or DN to move navigational mark to "Aileron and Rudder Trim" , press R or L to select Common or Flight Mode. The factory default is Common.

(4) Flap Trim: Refer to "(1) Flight Speed Switch".

(5) Flaperon Trim: Refer to "(1) Flight Speed Switch".

After finished the setting, press EXT to exit.

2.10 Device Output

Device output is composed of eight items. It can set up output switches and select the usage of levers, respectively. It can also Active, Inhibit or use other functions.

Press ENT to enter Main Menu, press UP or DN to move navigational mark to Model Menu. Press ENT to enter Model menu. Press UP or DN to select "Device Output" and press ENT to enter "Device Output" interface.

Below eight items can be adjusted: Motor, Flap, AUX2, AUX3, AXU4, AUX5, AUX6, and AUX7.

(1) Motor

Press UP or DN in Device output interface can change the "Motor" switch. It includes FMODE SW, MIX SW, ELEV D/R, AILE D/R, RUDD D/R, GEAR SW, SPSO SW, SPS1 SW, SPS2 SW, SPS3 SW, Left Trim, Right Trim, AUX4 KB, AUX5 KB, AUX6 KB, AUX7 KB, Spoiler Stick. Press R or L to select the setting switch, The default setting is GEAR SW.

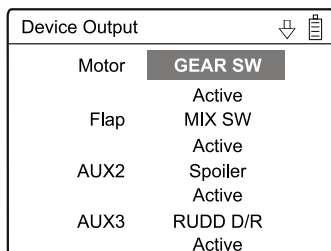
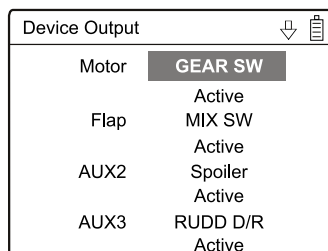

Press UP or DN to select Function Setting after you select the switch, Press R or L to select Inhibit, Active, Gyro. The default setting is Active. You can continue to set other items after finishing.

(2) Flap

Press UP or DN to move navigational mark to Flap. Press R or L to expand the menu including FMODE SW, MIX SW, ELEV D/R, AILE D/R, RUDD D/R, GEAR SW, SPSO SW, SPS 1SW, SPS2 SW, SPS3 SW, Left Trim, Right Trim, AUX4 KB, AUX5 KB, AUX6 KB, AUX7 KB, Spoiler. The default setting is MIX SW.

Function Setting: The default setting is Active.

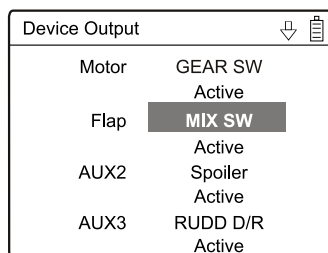

(3) AUX 2

Press UP or DN to move navigational mark to AUX2. Press R or L to expand the menu including FMODE SW, MIX SW, ELEV D/R, AILE D/R, RUDD D/R, GEAR SW, SPSO SW, SPS 1SW, SPS2 SW, SPS3 SW, Left Trim, Right Trim, AUX4 KB, AUX5 KB, AUX6 KB, AUX7 KB, Spoiler. The default setting is Spoiler.

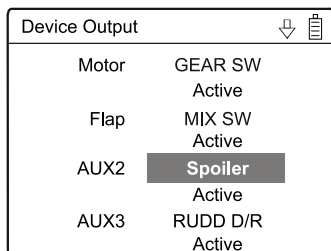

Press UP or DN to select the Function setting, press R or L to choose the switch, it includes Inhibit, Active, Gyro. The default setting is Active. You can continue to set other items after finished .

(4) AUX3, AUX4, AUX5, AUX6, AUX7 settings please refers to the AUX2 settings. AUX3 default setting is RUDD D/R, AUX4 default setting is AUX4 KB; AUX5 default setting is AUX5 KB; AUX6 default setting is AUX6 KB; AUX7 default setting is AUX7 KB.

After finished the setting, press EXT to exit.

2.11 Wing Type

The Wing Type includes V-Tail, Tip Ailerons, and Dual Spoilers.

Wing Type selection:

Press ENT to enter Main Menu, press UP or DN to move navigation mark to Model Menu. Press ENT to enter Model Menu. Press UP or DN to choose Wing Type, and press ENT to enter the Wing Type interface.

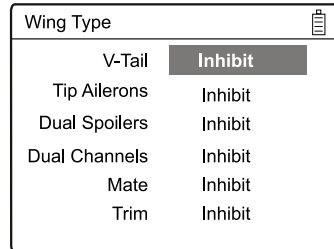

(1) V-Tail setting

Press UP or DN to move navigation mark to "V-Tail", press R or L to select the options, it including two options of Inhibit and Active. The default setting is Inhibit.

(2) Tip Ailerons setting:

Press UP or DN to move navigation mark to "Tip Ailerons", press R or L to select the options, it including two options of Inhibit and Active. The default setting is Inhibit.

(3) Dual Spoilers setting:

Press UP or DN to move navigation mark to "Dual Spoilers", press R or L to select the options, it including two options of Inhibit and Active. The default setting is Inhibit.

(4) Dual channels setting

It is possible to set Elevator, Rudder, and Flap in Dual channels, and is of two-channel output function. The AUX channel, which will be used as Dual channels setting at Device Output in Model Menu, should be previously set as Inhibit (Refer to "2.10 Device Output").

(4.1) Channel setting

Press UP or DN to move the navigational mark to item Dual Channels in the interface of Wing Type. Press R or L, there are items of Elevator, Rudder, and Flap. We take Elevator as an example.

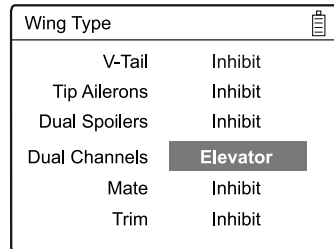

(4.2) Mate setting:

Press UP or DN to select "Mate" setting, press R or L to select the desired channel in the menu with Inhibit and the inhibited channels previously set in "Device Output".

(4.3) Trim Setting:

Press UP or DN to select "Trim" setting, press R or L to select the item you want to choose as trim lever in the menu with Inhibit, Left trim, Right Trim, AUX4 KB, AUX5 KB, AUX6 KB, AUX7 KB.

The setting of Rudder and Flap in the item Channel are same as above.

After the setting, press EXT to exit.

2.12 Power Amplifier

The transmission output power of DEVO F12E is adjustable. It is divided into six grades from small to big. The lower the transmission output power transmits, the shorter the radio range is, and the longer the stand-by time will be, the higher the transmission output power, the farer the radio range, and the shorter the stand-by time. Choose the appropriate transmission output power according to the actual situation.

Press ENT to enter Main Menu, press UP or DN to move navigation mark to Model Menu. Press ENT to enter Model Menu. Press UP or DN to select Power Amplifier and press ENT to enter Power Amplifier interface.

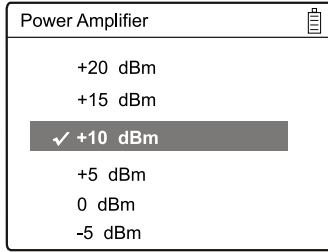

Press UP or DN to choose the desired output power value. Press ENT to confirm then the corresponding items will have "✓" mark in front of the items.

After the setting, press EXT to exit.

Grade 6	Grade 5	Grade 4	Grade 3	Grade 2	Grade 1
20dBm	15dBm	10dBm	5dBm	0dBm	-5dBm

2.13 Fixed ID

This setting will bind DEVO F12E with its receiver in a unique corresponding relationship. It will greatly speed up the time of automatic binding when DEVO F12E powered on.

(1) Setting for fixed ID

The setting for fixed ID should be under the status that automatic ID binding is successfully finished. Below is the setting method.

Press ENT to enter the main Menu and press UP or DN to move the navigational mark to select Model menu. Press ENT to enter Model Menu. Press UP or DN to select Fixed ID and press ENT to enter the Fixed ID setting interface.(Fig. 1)

If you want to activate the fixed ID settings, press R or L to change the status from off to ON. A series of random digits will be shown below after change to On. (Fig. 2)

Press UP or DN to choose the ID code setting, press R or L to choose the digits,press UP or DN to move to the next code setting . there are 6 digits can be setted. (Fig. 3)

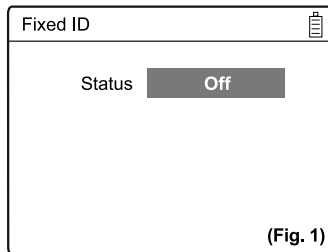

(Fig. 1)

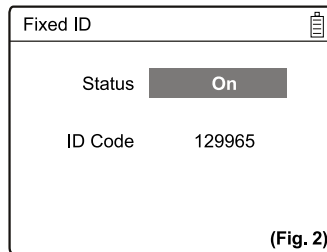

(Fig. 2)

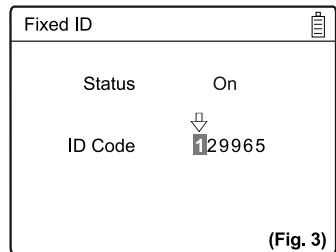

(Fig. 3)

Press ENT key after the new ID has been setted. An inquiry interface of "Are you sure?" pop up. "ID Code Matching" will be shown after press ENT. After matching, the interface will be returned to Model Menu.

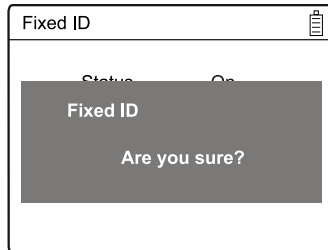

(2) Fixed ID cancellation

Insert the assorted BIND PLUG into the output terminal of BATT before the receiver is powered on, and then plug 5V DC power into other output terminal. The red light of receiver will flash slowly. This means the fixed ID code has been cancelled. Pull out bind plug. DEVO F12E also needs to make relative cancellation and revision after the fixed ID in receiver is cleared out.



In the main interface press the ENT to enter Model Menu and then press UP or DN to move the navigational mark to select Model Menu. Press ENT to enter Model Menu. Press UP or DN to select Fixed ID code and press ENT to enter the Fixed ID code interface. Press UP or DN to select Status option, Press R or L to change the status to Off. Then press EXT to exit.

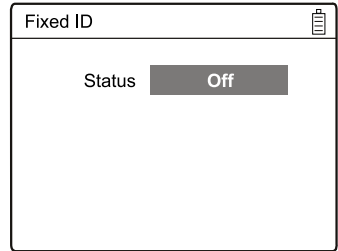

2.14 Sensor setting

Setting method: press ENT enter to the Main Menu. Press UP or DN to select the Model Menu. Press ENT enter to Model Menu. Press UP or DN to select sensor press ENT enter to the sensor setting interface. See the Illustration.

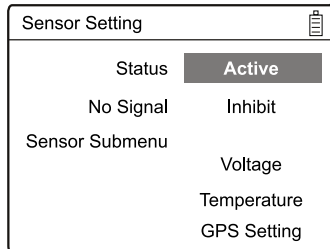

Press R or L to select Activate or Inhibit (the default setting is Inhibit), such as press Activate will includes No Signal Warning, Voltage sensor, Temperature sensor, GPS receiver setting etc.

(1) No Signal

Press UP or DN to make the navigation mark to choose "No Signal". Press R or L to choose "Inhibit" or "Active"(default setting is "inhibit"). If you choose "Active", the Radio will alarm when telemetry signal lost. Picture as left:

(2) Voltage setting

There are 3 different types of voltage can be measured. It includes Interna:V0, External:V1 and V2 which can be monitored two different external voltage(i.e. battery) respectively. Once the measured voltage is lower than the setting value, the Radio will alarm.

(2.1) Receiver V0(Internal) PFV(Power Feeding Voltage) Alarmed value can be setted as 3.6-6V

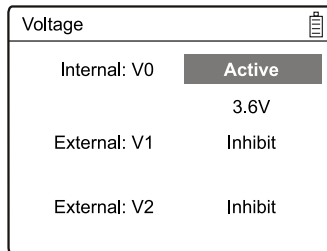
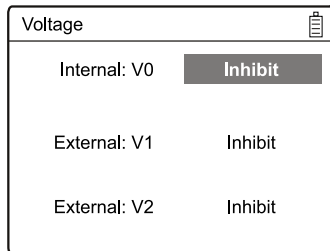

Voltage setting: press R or L to activate the V0, the alarm interface will appear in the interface, please refer to the Illustration.

Press UP or DN to select the Alarm Voltage setting, press R or L to set the value. The range is 3.6-6V. you can continue to set other items after you finished.

(2.2) External:V1

Press UP or DN enter to External:V1 setting interface. Press R or L to activate the V1, the details refers to the Illustration.

Press UP or DN to select the Alarm Voltage setting. Press R or L to set the value. The setting range is 0.2~99.9V. you can continue to set other items after you finished.

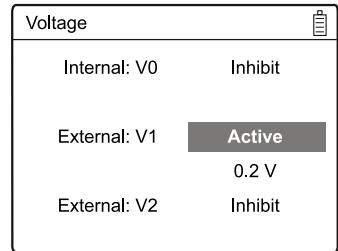
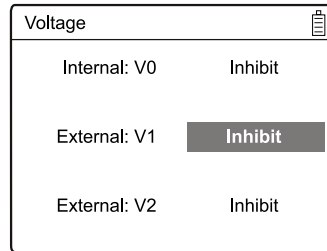

(2.3) External: V2 setting can refer to External V1 setting.

Press EXT back to sensor setting interface after you finished.

(3) Temperature sensor

The temperature sensor can measure up to 4 different temperature(i.e.motors).You can choose Celsius or Fahrenheit.The alarmed value can be setted to 4 different temperature.Once the measured value is higher than the setting value, the radio will alarm.The Alarm Temperature value can be setted as -20~220°C or -4.0~428.0° F.

Temperature Setting:

In the "Sensor Setting" interface, press UP or DN to make the navigation mark to choose "Temperature Sensor", and press ENT to enter "Temperature Sensor" setting interface. See the illustration.

(3.1) Unit

Press UP or DN to make the navigation mark to choose "Unit" setting item, and press R or L to choose Unit, two kinds of Unit: Celsius and Fahrenheit.

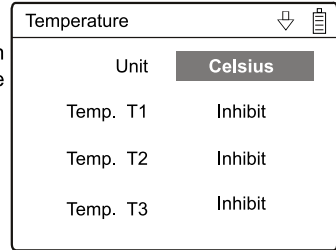

(3.2) Alarm Temperature settings

Press UP or DN select the T1, Press R or L to Active the setting. Inhibit will change to Active and Alarm temperature will be shown. If you choose Inhibit, the Alarm temperature value won't be shown.

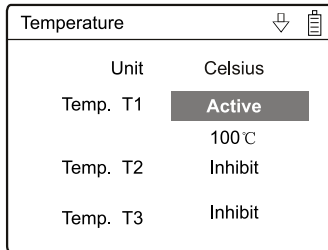

Press UP or DN to select "Alarm" setting, press R or L to set the alarm temperature value. Press UP or DN to set other items after finishing the setting.

(3.3) T2, T3, T4 setting

Refer to the step of "(3.2)T1".

(4) GPS setting

There are 4 items including Altitude Type, Speed Unit, Date Type and Time Zone in the GPS receiver setting interface.

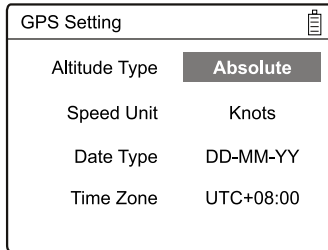

Press UP or DN to select the Sensor setting interface to enter the GPS setting interface.

(4.1) Altitude Type

Press UP or DN to select the Altitude type on the GPS setting interface and it's Absolute and Relative.

(4.2) Speed Unit

Press UP or DN to select the Speed Unit on the GPS setting interface and it includes knots and km/h and relative. Select the desired item.

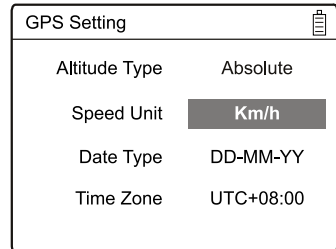
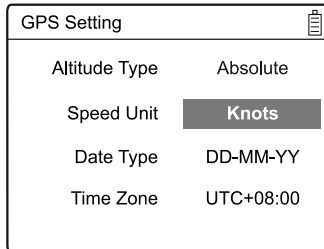

(4.3) Date Type

Press UP or DN to select the Date Type on the GPS setting interface and it includes DD-MM-YY, MM-DD-YY and YY-MM-DD. Select the desired item.

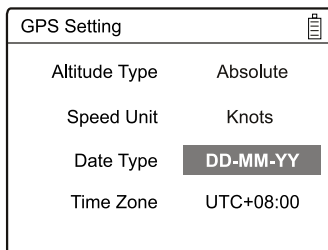

(4.3) Date Type

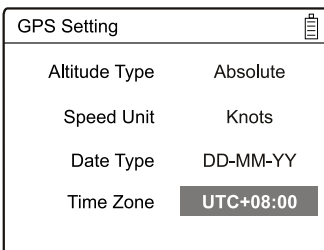

(4.4) Time Zone

(4.4) Time Zone

Press UP or DN to select the Time Zone, press R or L to set the desired Time Zone.

3.0 Function Menu

Function Menu can help you custom adjustments for the selected models. The menu includes such items as Reverse Switch, Travel Adjust, Sub Trim, Dual Rate and Exponential, Motor Hold, Flaperon Mix, Camber System, Differential, Balance, Gyro Sensor, Rudder to Spoiler Mix, Aileron to Rudder Mix, Elevator to Flap Mix, Aileron to Flap Mix, Aileron to Tip Aileron Mix, Flap Rate, Brake System, Program Mix, Monitor, Fail Safe, Sensor view, Trainer and Timer.

3.1 Reverse Switch

Press ENT to enter Main Menu; Press UP or DN to move the navigation mark to Function Menu, and press ENT to enter Function Menu. Press UP or DN to choose Reverse Switch and Press ENT to enter Reverse Switch interface.

Reverse Switch	
Elevator	Reverse
R-Aileron	Normal
L-Aileron	Normal
Rudder	Normal
Motor	Normal
Flap	Normal
AUX2	Normal
AUX3	Normal

Reverse Switch	
Elevator	Normal
R-Aileron	Normal
L-Aileron	Normal
Rudder	Normal
Motor	Normal
Flap	Normal
AUX2	Normal
AUX3	Normal

Press UP or DN to move navigation mark to ELE (take Elevator for example), press R or L to shift the status between normal and reverse. These are two status for option. And the default setting is Normal. All Channels Reverse Switch like: R-Aileron, L-Aileron, Rudder, Motor, Flap, AUX2, AUX3, AUX4, AUX5, AUX6 and AUX7 can be referred to the way of ELEV Reverse Switch. And press EXT to exit after finishing setting.

3.2 Travel Adjust

Press ENT to enter into Main Menu. Press UP or DN to move navigation mark to select item Function Menu. Press ENT to enter Function Menu. Press UP or DN to select Travel Adjust, Press ENT to enter Travel Adjust interface, as below illustration. It shows the Travel Adjust status of one channel:

Travel Adjust	
Elevator	U100.0%
	D100.0%
R-Aileron	L100.0%
	R100.0%
L-Aileron	L100.0%
	R100.0%
Rudder	L100.0%
	R100.0%

Take Elevator for example, Press UP or DN to move navigation mark to desired item Elevation of U. Press R or L to increase or decrease the servo travel range. The adjustment range is from 0.0% to 150.0%. The factory default is 100.0%.

Press UP or DN to move navigation mark to desired item Elevation of D. Press R or L to increase or decrease the servo travel range. The adjustment range is from 0.0% to 150.0%. The factory default is 100.0%.

All other channel's Travel Adjust like R-Aileron, L-Aileron, Rudder, Motor, Flap, AUX2, AUX3, AUX4, AUX5, AUX6 and AUX7 can be referred to Elevator travel Adjust. Press EXT to exit after setting finished.

3.3 Sub Trim

Sub Trim can move the neutral point of the servo. But we advise you to mechanically adjust the servo bell crank if offset is far away from the neutral point of servo, because excessive usage of the sub trim may damage the servo.

Setting method:

Press ENT to enter Main Menu, Press UP or DN to move the navigation mark to select item Function Menu. Press ENT to enter Function Menu, Press UP or DN to select Sub trim, and press ENT to enter Sub Trim interface.

Sub Trim	
Elevator	0.0%
R-Aileron	0.0%
L-Aileron	0.0%
Rudder	0.0%
Motor	0.0%
Flap	0.0%
AUX2	0.0%
AUX3	0.0%

The interface show the items and the channels which are adjustable. Press R or L to change the neutral point of Servos. The factory default is 0.0%. Press UP or DN to choose desired items. The range as below:

Channel name	Adjustment range	Channel name	Adjustment range
Elevator	D62.5% ~ U62.5%	AUX2	-62.5% ~ +62.5%
R-Aileron	R62.5% ~ L62.5%	AUX3	-62.5% ~ +62.5%
L-Aileron	R62.5% ~ L62.5%	AUX4	-62.5% ~ +62.5%
Rudder	R62.5% ~ L62.5%	AUX5	-62.5% ~ +62.5%
Motor	-62.5% ~ +62.5%	AUX6	-62.5% ~ +62.5%
Flap	D62.5% ~ U62.5%	AUX7	-62.5% ~ +62.5%

Press EXT to exit after adjustment finished.

3.4 Dual Rate and Exponential

After this function is set up, it is possible for D/R switches to control the dual rates of elevator, aileron and rudder, respectively. The setting range is covered from 0% to 125%. Under the help with exponential curve adjustment, it is possible to make both customized setting and automatic setting. The switch between Dual rate and Exponential can be performed via pushing or pulling the Flight Mode Lever.

Press ENT to enter Main Menu. Press UP or DN to move navigation mark to desired item Function Menu. Press ENT to enter Function Menu, press UP or DN to choose Dual rate and Exponential, Press ENT to enter D/R and Exponential interface.

(1) Channel selection

Press UP or DN to move navigation mark of Channel, Press R or L to set up channels containing Elevator, Aileron and Rudder. Choose the desired channel for setting.

Dual Rate and Exponential	
Pos 0	
Channel	Elevator
Position	Pos 0
Dual Rate	100%
Exponential	Line
Cruise Mode	Switch
Speed Mode	Switch
Thermal Mode	Switch



(2) Position selection

Press UP or DN to move navigation mark to desired item Position.

In the manual mode, the function of Dual rate and Exponential will be executed by the corresponding D/R switch among Pos0 and Pos1. Take the item Elevator at channel as an example. It's possible to shift between Pos0 and Pos1 via pushing or pulling the D/R switch.

(3) Dual Rate adjustment

Press UP or DN to move the navigation mark to desired item Dual Rate, press R or L to change the number and then you can change the dual rate of the position. The factory default setting is 100%.

Dual Rate and Exponential	
Pos 0	
Channel	Elevator
Position	Pos 0
Dual Rate	100%
Exponential	Line
Cruise Mode	Switch
Speed Mode	Switch
Thermal Mode	Switch

(4) Exponential

Press UP or DN to select Exponential item of navigation mark. It's possible to change Dual Rate and Exponential value in Pos when pressing R or L to change the value. There are ± 100% and Line three adjustment.

Dual Rate and Exponential	
Pos 0	
Channel	Elevator
Position	Pos 0
Dual Rate	100%
Exponential	Line
Cruise Mode	Switch
Speed Mode	Switch
Thermal Mode	Switch

(5) Automatic setting

Under working with Flight Mode, it's possible to switch the Dual Rate and Exponential, which are set in above"(3) Dual Rate adjustment" and "(4) Exponential adjustment", respectively.



The settings for Cruise Mode, Speed Mode, Thermal Mode, Launch Mode and Land Mode 5 are available.

Note: If want to use this function, it is necessary to previously set both "Flight Speed Switch" and "Flight Launch Switch" at Device Select in Model Menu as the corresponding switches. Refer to "2.9 Device Select".

(5.1) Cruise Mode setting:

Press UP or DN in the navigation mark of Dual Rate and Exponential to select the desired item Cruise Mode. Press R or L to set the position and the Switch. Only the D/R switch control is valid When Switch is selected, under the Flight Mode, it's possible for Pos to switch the Dual Rate and Exponential, which are set in above(3) and (4)Exponential adjustment. The settings for Swtich, Pos0, Pos1, Pos2 , Pos3, Pos4 are valid.

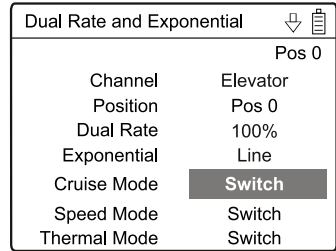

(5.2) The setting for Speed Mode, Thermal Mode, Launch Mode, Land Mode can be set up according to above Cruise Mode Setting. Press EXT to exit after finishing the setting.

3.5 Motor Hold

The Motor Hold can be switched after the function is used. The setting range of Motor Hold is from -10% to 100%. The item Motor should be previously set at Device Output in Model Menu, which is used as Spoiler Stick and is activated. Refer to "2.10 Device Output".

Setting method:

Press ENT to enter Main Menu; Press UP or DN to move the navigation mark to Function Menu, and press ENT to enter Function Menu. Press UP or DN to choose Motor Hold and Press ENT to enter Motor Hold interface.

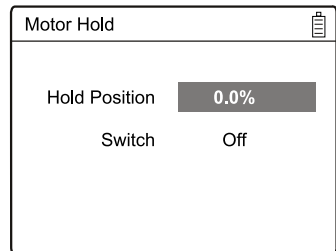

(1) Hold Position

In the Motor Hold interface, press UP or DN to move the Navigation mark to choose "Hold Position" setting options. Press R or L to increase or decrease the amount respectively. The adjustable range is from -10.0% to 100.0% and the default setting is 0.0%.

(2) Switch Selection

Press UP or DN to choose the navigation mark of Switch setting item and press ENT to enter the select interface of Switch. Press UP or DN to select the switch you want and a "✓" will be shown in its left. If two or more switches are chosen, the item "And" should be selected. Press EXT to exit after setting up finished.

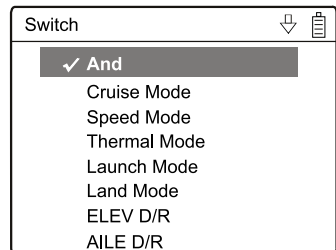
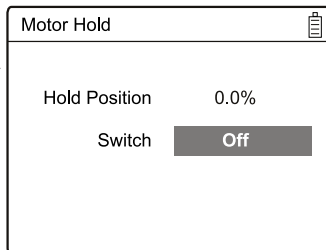

3.6 Flaperon Mix

This function is used to Mix Aileron to Flaperon, or Mix Elevator to Flaperon. The Mix amount can be independently set in each flight mode.

The Flap Rate in each flight mode should be previously set before using this function. Refer to the following "3.16 Flap Rate".

Setting method:

Press ENT to enter Main Menu; Press UP or DN to move the navigation mark to Function Menu, and press ENT to enter Function Menu. Press UP or DN to choose Flaperon Mix and Press ENT to enter Flaperon Mix interface. Picture as right:

Flaperon Mix	
Offset	0%
Flight Mode	Cruise Mode
Flap to Flaperon	
Up	0%
Down	0%
Flap to Elevator	
Up	0%
Down	0%

(1) Flap Lever Offset setting

This function can be used to set the neutral points of Flaperon servos.

Press UP or DN to move the Navigation mark to choose "Flap Lever Offset" setting options. Press R or L to increase or decrease the amount respectively. The adjustable range is $\pm 100\%$. It is possible to change the offset direction by changing the plus or minus sign before the amount.

(2) Flight Mode setting

The flight mode should be previously activated in "Device Select" before using this function (Refer to "2.9 Device Select").

Press UP or DN to move the Navigation mark to select "Flight Mode" setting options, press R or L to select the desired item.

(3) Flap to Flaperon setting

Press UP or DN to move the Navigation mark to choose "UP or Down" setting options. Press R or L to change the Flaperon Mix value when moving the Flap stick. The bigger the Value is, the bigger Mix will be. The adjustable Mix is ranged from -125% to $+125\%$. It is possible to change the Flaperon Mix direction by changing the plus or minus sign before the value.

Flaperon Mix	
Offset	0%
Flight Mode	Cruise Mode
Flap to Flaperon	
Up	0%
Down	0%
Flap to Elevator	
Up	0%
Down	0%

(4) Flap to Elevator setting

Press UP or DN to move the Navigation mark to choose "UP or Down" setting options. Press R or L to change the Elevator Mix value when moving the Flap stick. The bigger the Value is, the bigger Mix will be. The adjustable Mix is ranged from -125% to $+125\%$. It is possible to change the Elevator Mix direction by changing the plus or minus sign before the value.

Press EXT to exit after finishing the setting.

3.7 Camber System

This function can change the Aileron angel, which goes through the central line of the main wings' transect, and then change the features of main wings.

Setting method:

Press ENT to enter Main Menu; Press UP or DN to move the navigation mark to Function Menu, and press ENT to enter Function Menu. Press UP or DN to choose Camber System and Press ENT to enter Camber System interface. Picture as right:

Camber System	
Flight Mode	Cruise Mode
L-Aileron	0%
R-Aileron	0%
L-Flap	0%
R-Flap	0%
L-Tip Aileron	0%
R-Tip Aileron	0%

(1) Flap Lever Offset setting

The flight mode should be previously activated in "Device Select" before using this function (Refer to "2.9 Device Select").

Press UP or DN to move the Navigation mark to select "Flight Mode" setting options, press R or L to select the desired item.

(2) L-Aileron/ R-Aileron setting

Press UP or DN to move the Navigation mark to choose "L-Aileron or R-Aileron" setting options. Press R or L to change the position of L-Aileron or R-Aileron with a range of $\pm 100\%$. It is possible to alter the direction of L-Aileron or R-Aileron via changing the letter of "R" or "L" before the amount.

(3) L-Flap/ R-Flap setting

The Flap Dual Channels should be previously set in Wing Type (refer to "2.11 Wing Type").

Press UP or DN to move the Navigation mark to choose "L-Flap or R-Flap" setting options. Press R or L to change the position of L-Flap or R-Flap with a range of $\pm 100\%$. It is possible to alter the direction of L-Flap or R-Flap via changing the letter of "R" or "L" before the amount.

(4) L-Tip Aileron/ R-Tip Aileron setting

The Tip Aileron should be previously set at Wing Type (refer to "2.11 Wing Type").

Press UP or DN to move the Navigation mark to choose "L-Tip Aileron or R-Tip Aileron" setting options. Press R or L to change the position of L-Tip Aileron or R-Tip Aileron with a range of $\pm 100\%$. It is possible to alter the direction of L-Tip Aileron or R-Tip Aileron via changing the letter of "R" or "L" before the amount.

Press EXT to exit after finishing the setting.

3.8 Differential

The flight mode should be previously activated in "Device Select" before using this function (Refer to "2.9 Device Select").

Differential	
Flight Mode	Cruise Mode
Aileron	0%
Rudder	0%
Flap	0%
Tip Aileron	0%
Brake Differe...	0%

Press ENT to enter Main Menu; Press UP or DN to move the navigation mark to Function Menu, and press ENT to enter Function Menu. Press UP or DN to choose Differential and Press ENT to enter Differential interface. Picture as left:

(1) Flight Mode setting

Press UP or DN to make the Navigation mark to select "Flight Mode" setting options, press R or L to select the desired item.

(2) Aileron differential setting

It is possible to decrease the vibration to the head from reverse direction in operating aileron.

Press UP or DN to move the Navigation mark to select "Aileron" setting options, press R or L to increase or decrease, respectively, the value with a range of $\pm 100\%$.

Differential	
Flight Mode	Cruise Mode
Aileron	0%
Rudder	0%
Flap	0%
Tip Aileron	0%
Brake Differe...	0%

(3) Rudder differential setting

In this function, the left or right rudder in V-Tail will produce differential gearshift. V-Tail should be previously set in Wing Type at Model Menu (refer to "2.11 Wing Type").

Press UP or DN to move the Navigation mark to select "Rudder" setting options, press R or L to increase or decrease, respectively, the value with a range of $\pm 100\%$.

(4) Flap differential setting

Flap Dual channels should be previously set at Wing Type in Model Menu (refer to "2.11 Wing Type").

Press UP or DN to move the Navigation mark to select "Flap" setting options, press R or L to increase or decrease, respectively, the value with a range of $\pm 100\%$.

(5) Tip Aileron differential setting

Tip Aileron should be previously set at Tip Aileron in Model Menu (refer to "2.11 Wing Type").

Press UP or DN to move the Navigation mark to select "Tip Aileron" setting options, press R or L to increase or decrease, respectively, the value with a range of $\pm 100\%$.

(6) Brake differential setting

If co-working with the spoiler stick, the brake differential function can counteract the differential.

Press UP or DN to move the Navigation mark to select "Brake" setting options, press R or L to increase or decrease, respectively, the value with a range from 0% to 100%.

Press EXT to exit after finishing the setting.

Differential	
Flight Mode	Cruise Mode
Aileron	0%
Rudder	0%
Flap	0%
Tip Aileron	0%
Brake Differ...	0%

3.9 Balance

This function can adjust the two-servo parameters, which are simultaneously used in dual output channels, but "Dual Channels" should be previously activated at Wing Type in Model Menu (Refer to "2.11 Wing Type").

Setting method:

Press ENT to enter Main Menu; Press UP or DN to move the navigation mark to Function Menu, and press ENT to enter Function Menu. Press UP or DN to choose Balance and Press ENT to enter Balance interface. Picture as right:

Balance	
Channel	Aileron
Point < Right	Active 0%
Point - Right	Active 0%
Point - 1	Inhibit

(1) Channel selection

Press UP or DN to move navigation mark of Channel, Press R or L to select the desired item.

Balance	
Channel	Aileron
Point < Right	Active 0%
Point - Right	Active 0%
Point - 1	Inhibit

(2) Point parameter adjustment

Point< Right Setting: Press UP or DN to choose "Point< Right". If need to adjust the value, press L (0% means no adjusting). A minus value means the amending direction is downward; press R to adjust value(0% means no adjusting). A plus value means the amending direction is upward. The adjustable range is ±100%.

Point-Right Setting: Press UP or DN to choose "Point-Right". Press R or L to Inhibit or Active. If need to adjust please Active it. There will be expanded value adjustment item. Press UP or DN to choose "0%" If need to adjust the value, press L (0% means no adjusting). A minus value means the amending direction is downward; press R to adjust value (0% means no adjusting). A plus value means the amending direction is upward. The adjustable range is 100%.

Press UP or DN, there will be setting for Point-1, Point-2, Point-3, Point-Left, Point>Left, refer to the setting method as above. Press EXT after finished it.

3.10 Gyro Sensor

This function offers the gain adjustment for gyro sensor. It is possible to be automatically switched among various gains via flight mode, which should be previously set at Device Select in Model Menu (Refer to "2.9 Device Select"), and the gyro output should also be simultaneously set at Device Output (Refer to "2.10 Device Output").

Press ENT to enter Main Menu; Press UP or DN to move the navigation mark to Function Menu, and press ENT to enter Function Menu. Press UP or DN to choose Gyro Sensor and Press ENT to enter Gyro Sensor interface. Picture as right:

Gyro Sensor	
Land Mode	
Channel	AUX2
Cruise Mode	50.0%
Speed Mode	50.0%
Thermal Mode	50.0%
Launch Mode	50.0%
Land Mode	50.0%

(1) Mode: System default mode is Automatic.

(2) Channel: The displaying is the sensitivity channel of Gyro. Refer to "2.10 Device Output" to select.

(3) Status:

Turn the Flight Mode Switch, the status display present flight mode position. There are "Cruise Mode", "Speed Mode", "Thermal Mode", "Launch Mode", "Land Mode" sets.

(3.1) Cruise Mode:

Press UP or DN to select Cruise Mode, press R or L can increase or decrease the value individually. If the gyro used has two modes of NOR and AVCS, NOR will be activated when the value is less than 50.0%. In NOR mode, the smaller the value is, the bigger the gyro sensor sensitivity will be; In AVCS Mode, the bigger the value is, the bigger the gyro sensor sensitivity will be. The factory setting is 50.0%.

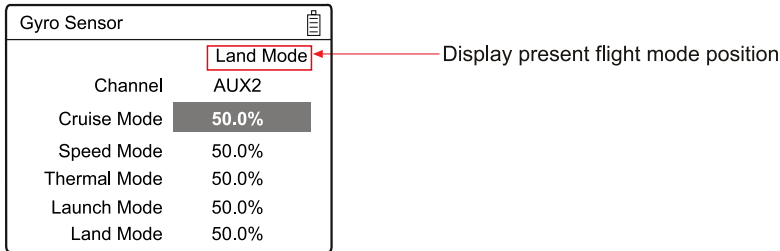

(3.2) "Speed Mode", "Thermal Mode", "Launch Mode", "Land Mode" 4 settings refer to "Cruise Mode".

After finishing the set, press EXT to exit.

3.11 Rudder to Spoiler Mix

When this function is activated, the spoiler can be used as Rudder in the models without Rudder and can also be mixed. The mix gain can be independently set in each flight mode, which should be previously set at Device Select in Model Menu (Refer to "2.9 Device Select"), and "Dual Spoilers" should also be activated at Wing Type (Refer to "2.11 Wing Type").

Setting method:

Press ENT to enter Main Menu; Press UP or DN to move the navigation mark to Function Menu, and press ENT to enter Function Menu. Press UP or DN to choose Rudder to Spoiler Mix and Press ENT to enter Rudder to Spoiler Mix interface. Picture as right:

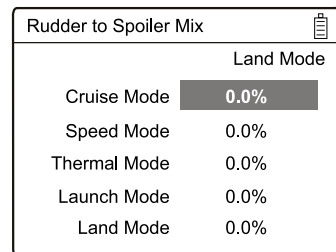

There are five flight modes: Cruise Mode, Speed Mode, Thermal Mode, Launch Mode, Land Mode. Press UP or DN to move the navigation mark to select the desired flight mode. Press R or L to increase or decrease amount respectively. The adjustable range is from 0.0% to 100.0% and the default setting is 0.0%.

After finishing the set, press EXT to exit.

3.12 Aileron to Rudder Mix

This function aims at mixing the rudder when operating the aileron. The mix value can be respectively set in each flight mode. But the flight mode should be previously set at Device Select in Model Menu (Refer to "2.9 Device Select").

Setting method:

Press ENT to enter Main Menu; Press UP or DN to move the navigation mark to Function Menu, and press ENT to enter Function Menu. Press UP or DN to choose Aileron to Rudder Mix and Press ENT to enter Aileron to Rudder Mix interface. Picture as right:

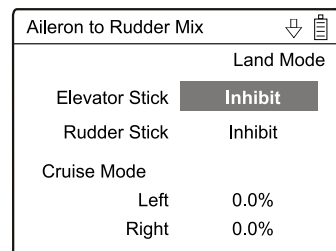

(1) Elevator Stick setting

This function is that: if the elevator stick position is set at one point, this point will become the cut-off point whether to mix. when the elevator stick is moved down from this point, the mix will be cancelled; While the elevator stick is moved up from this point, the mix will be activated.

Press UP or DN to move the Navigation mark to select "Elevator Stick" setting options, press R or L to increase or decrease, respectively, the value with a range of D1%-100%. When the elevator stick is moved down from the set value, the mix will be cancelled; while the elevator stick up from this value, the mix will be activated. The default setting is Inhibit.

(2) Rudder Stick setting

The setting is same as above. The adjustable rang is from L/R1% to L/R100%, and the factory setting is Inhibit.

(3) Mix value setting for each flight mode

There are total five flight modes. The flight mode should be previously set at Device Select in Mode Menu (Refer to "2.9 Device Select").

Aileron to Rudder Mix		↓	☰
		Land Mode	
Elevator Stick	Inhibit		
Rudder Stick	Inhibit		
Cruise Mode			
Left	0.0%		
Right	0.0%		

Press UP or DN to move the Navigation mark to select the desired flight mode of "Left" setting options. Press R or L to change Rudder mix value when moving the aileron stick leftward. It is possible to change the mix direction via changing the plus or minus sign before the value. The adjustable mix is ±125%.

Press UP or DN to move the Navigation mark to select the desired flight mode of "Right" setting options. Press R or L to change Rudder mix valuer when moving the aileron stick rightward. It is possible to change the mix direction via changing the plus or minus sign before the value. The adjustable mix is ±125%. After finishing the set, press EXT to exit.

3.13 Elevator to Flap Mix

This function aims at mixing flap when operating elevator stick. It can be respectively set in each flight mode, which should be previously set at Device Select in Mode Menu (Refer to "2.9 Device Select").

Setting method:

Press ENT to enter Main Menu; Press UP or DN to move the navigation mark to Function Menu, and press ENT to enter Function Menu. Press UP or DN to choose Elevator to Flap Mix and Press ENT to enter Elevator to Flap Mix interface. Picture as right:

Elevator to Flap Mix		↓	☰
Cruise Mode			
Up	0%		
Down	0%		
Offset	0%		
Speed Mode			
Up	0%		
Down	0%		
Offset	0%		

(1) Cruise Mode

(1.1) UP setting

Press UP or DN to move the Navigation mark to select "UP" setting options in the Cruise Mode. Press R or L to change Flap mix value when moving the Elevator stick upward. It is possible to change the mix direction via changing the plus or minus sign before the value. The adjustable mix is ±125%.

(1.2) Down setting

Press UP or DN to move the Navigation mark to select "Down" setting options in the Cruise Mode. Press R or L to change Flap mix value when moving the Elevator stick downward. It is possible to change the mix direction via changing the plus or minus sign before the value. The adjustable mix is ±125%.

(1.3) Offset setting

Press UP or DN to move the Navigation mark to select "Offset" setting options in the Cruise Mode. Press R or L to amend the central point of flap servo. The bigger the value is, the bigger the offset will be. It is possible to change the offset direction via changing the plus or minus sign before the value. The adjustable offset range is ±100%.

(2) "Speed Mode", "Thermal Mode", "Launch Mode", "Land Mode" 4 settings refer to "(1) Cruise Mode".

After finishing the set, press EXT to exit.

3.14 Aileron to Flap Mix

This function aims at mixing flap when operating aileron stick. it can be respectively set in each flight mode. But the flight mode should be previously set at Device Select in Mode Menu (Refer to "2.9 Device Select"), and the flap dual channels should also be previously activated at Wing Type in Mode Menu (Refer to "2.11 Wing Type").

Setting method:

Press ENT to enter Main Menu; Press UP or DN to move the navigation mark to Function Menu, and press ENT to enter Function Menu. Press UP or DN to choose Aileron to Flap Mix and Press ENT to enter Aileron to Flap Mix interface. Picture as right:

Aileron to Flap Mix		Land Mode
Cruise Mode		
Left	0%	
Right	0%	
Speed Mode		
Left	0%	
Right	0%	

(1) Cruise Mode

(1.1) Left setting

Press UP or DN to move the Navigation mark to select "Left" setting options in the Cruise Mode. Press R or L to change Flap mix value when moving the Aileron stick leftward. It is possible to change the mix direction via changing the plus or minus sign before the value. The adjustable mix is $\pm 125\%$.

(1.2) Right setting

Press UP or DN to move the Navigation mark to select "Right" setting options in the Cruise Mode. Press R or L to change Flap mix value when moving the Aileron stick rightward. It is possible to change the mix direction via changing the plus or minus sign before the value. The adjustable mix is $\pm 125\%$.

(2) "Speed Mode", "Thermal Mode", "Launch Mode", "Land Mode" 4 settings refer to "(1) Cruise Mode".

After finishing the set, press EXT to exit.

3.15 Aileron to Tip-Aileron Mix

This function aims at mixing Tip-Aileron when operating Flap. it can be respectively set in each flight mode. But the flight mode should be previously set at Device Select in Mode Menu (Refer to "2.9 Device Select"), and the Tip-Aileron should also be activated at Wing Type in Mode Menu (Refer to "2.11 Wing Type").

Setting method:

Press ENT to enter Main Menu; Press UP or DN to move the navigation mark to Function Menu, and press ENT to enter Function Menu. Press UP or DN to choose Aileron to Tip Aileron Mix and Press ENT to enter Aileron to Tip Aileron Mix interface. Picture as right:

Aileron to Tip Aileron Mix		Land Mode
Cruise Mode		
Left	+100%	
Right	+100%	
Speed Mode		
Left	+100%	
Right	+100%	

(1) Cruise Mode

(1.1) Left setting

Press UP or DN to move the Navigation mark to select "Left" setting options in the Cruise Mode. Press R or L to change the Tip Aileron mix value when moving the Aileron stick leftward. It is possible to change the mix direction via changing the plus or minus sign before the value. The adjustable mix is $\pm 125\%$. The default setting is 100%.

(1.2) Right setting

Press UP or DN to move the Navigation mark to select "Right" setting options in the Cruise Mode. Press R or L to change the Tip Aileron mix value when moving the Aileron stick rightward. It is possible to change the mix direction via changing the plus or minus sign before the value. The adjustable mix is $\pm 125\%$. The default setting is 100%.

(2) "Speed Mode", "Thermal Mode", "Launch Mode", "Land Mode" 4 settings refer to "(1) Cruise Mode".

After finishing the set, press EXT to exit.

3.16 Flap Rate

This function can set the Flap Rate in all the flight modes. 0% is set the neutral center of Flap angle. It is possible to set the Flap Rate of either upward or downward direction. There are total five flight modes, each one of which should be previously set at Device Select in Mode Menu (Refer to "2.9 Device Select").

Setting method:

Press ENT to enter Main Menu; Press UP or DN to move the navigation mark to Function Menu, and press ENT to enter Function Menu. Press UP or DN to choose Flap Rate and Press ENT to enter Flap Rate interface. Picture as right:

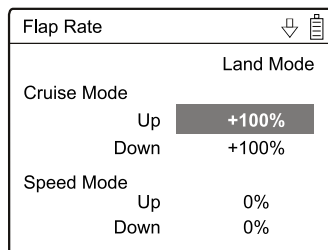

(1) Cruise Mode

(1.1) Up setting

Press UP or DN to move the Navigation mark to select "Up" setting options in the Cruise Mode. Press R or L to change the Flap Rate when Flap moving upward. It is possible to change the direction by changing the plus or minus sign before the value. The adjustable mix is $\pm 125\%$. The default setting is 100%.

(1.2) Up setting

Press UP or DN to move the Navigation mark to select "Down" setting options in the Cruise Mode. Press R or L to change the Flap Rate when Flap moving downward. It is possible to change the direction by changing the plus or minus sign before the value. The adjustable mix is $\pm 125\%$. The default setting is 100%.

(2) "Speed Mode", "Thermal Mode", "Launch Mode", "Land Mode" 4 settings refer to "(1) Cruise Mode".

After finishing the set, press EXT to exit.

3.17 Brake System

Through the spoiler stick operation, all the actions caused by mobile wings in main wings will be turned into the mix which aims at brake. It can be switched between Pos 0 and Pos 1 via setting the item switch.

Setting method:

Press ENT to enter Main Menu; Press UP or DN to move the navigation mark to Function Menu, and press ENT to enter Function Menu. Press UP or DN to choose Brake System and Press ENT to enter Brake System interface. Picture as right:

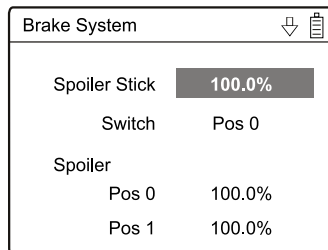

(1) Spoiler stick setting

When the spoiler stick is set at one certain point, this point will become the cut-off point whether to brake. The mixing will be working when the spoiler stick is being moved to this point from down to up.

Press UP or DN to move the Navigation mark to select "Spoiler Stick" setting options. The spoiler stick position will be set through pressing R or L to change the value. The adjustable range is from 0.0% to 100.0% and the default value is 100.0%.

(2) Switch Selection

Press UP or DN to move the Navigation mark to select "Switch". Press ENT to enter Switch interface, press

UP or DN to choose desired switch item. Press ENT to confirm, the desired switch item whose left side will be changed into "1" from "0". If two or more items are selected, the item And should be selected, whose left side should be changed into "1" from "0". Press EXT after finished it.

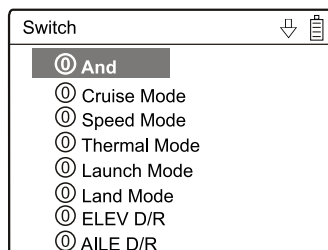
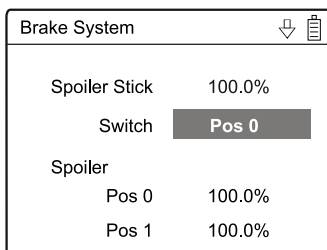

(3) Brake to Spoiler setting

Press UP or DN to move the Navigation mark to select "Pos 0" in the Brake to Spoiler setting interface. The brake mix at Pos0 will be altered through pressing R or L to change the value. The adjustable value is 0.0-100.0%, and the default setting is 100.0%

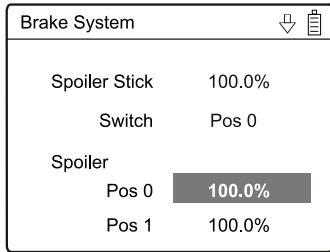

Press UP or DN to move the Navigation mark to select "Pos 1" in the Brake to Spoiler setting interface. The brake mix at Pos1 will be altered through pressing R or L to change the value. The adjustable value is 0.0-100.0%, and the default setting is 100.0%

(4) Brake to Flaperon setting

The setting is same as above. It is possible to change the mix direction through changing the plus or minus sign before the value. The adjustable value is ±125%, and the default setting is 0%.

(5) Brake to Elevator: The setting is same as above.

(6) Brake to Flap: The setting is same as above.

(7) Brake to Tip Aileron: The setting is same as above.

After finishing the set, press EXT to exit.

3.18 Program mix

There are 8 series of program mix, mix channels and values are adjustable.

Setting Method:

Press ENT enter to Main Menu. Press UP or DN select function, press ENT to enter function menu, then press UP or DN select "Program Mix". And press ENT to program Mix setting and current status (default setting is "Inhibit") interface. Press R or L to choose Inhibit, Normal or Curve.

Take "program mix 1" for example, there are "Normal" and "Curve" setting.

(1) The "Normal" setting of "program mix"

Press UP or DN select the "Normal" setting, Press ENT button then pop up "All Servos Hold?" Press R or L to choose OK or Cancel. If "OK" selected, all the servos will be locked in the current status, if "Cancel" selected, all servos are unlocked. Press ENT enter to Program Mix 1 setting interface.

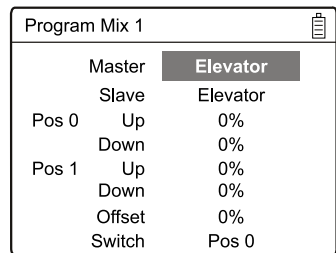
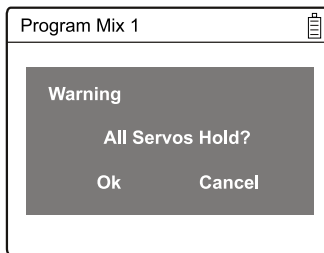
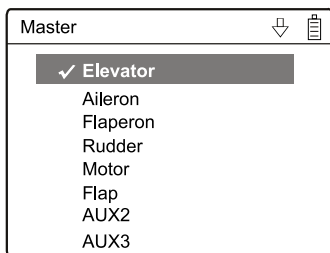
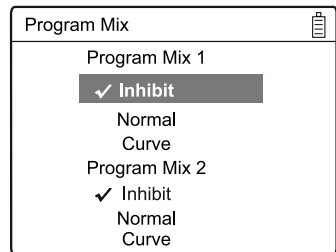

(1.1) Master channel setting

Press UP or DN to move the navigational mark to select Master option and press ENT to Master interface. Press UP or DN to select the desired channel and press ENT to make a "✓". Press EXT to be back to Program Mix 1 interface.

(2) Slave channel setting

Press UP or DN to move the navigational mark to select Slave option and press ENT to Slave interface. Press UP or DN to select the desired channel and press ENT to make a “√”. Press EXT to be back to Program Mix1 interface.

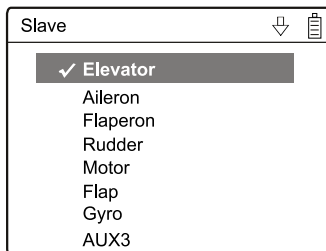

(1.3) Gain setting: Take Elevator at Master as an example.

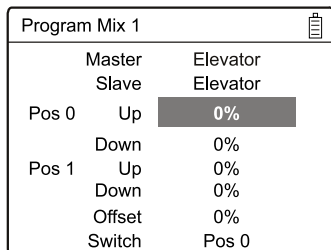

(1.3.1) Pos 0 UP:

Mix amount setting when elevator stick moved upward.

Press UP or DN to move the navigational mark to select "Pos 0 Up" item. Press R or L to increase or decrease, separately, the mix amount. It is possible to change the mix direction through changing the plus or minus sign before amount. The adjustable range is $\pm 125\%$.

(1.3.2) Pos 0 Down:

Mix amount setting when elevator stick moved downward.

Press UP or DN to move the navigational mark to select "Pos 0 Down" item. Press R or L to increase or decrease, separately, the mix amount. It is possible to change the mix direction through changing the plus or minus sign before amount. The adjustable range is $\pm 125\%$.

(1.3.3) Pos 1 Up setting method refer to (1.3.1) Pos 0 Up setting.

(1.3.4) Pos 1 Down setting method refer to (1.3.1) Pos 0 Down setting.

(1.3.5) Offset Setting

This function can make Slave begin to mix through the corresponding Lever switch from a certain point as the starting point.

Press UP or DN to move the navigational mark to select "Offset" item. Press R or L to increase or decrease, separately, the mix amount. It is possible to change Offset direction through changing the plus or minus sign before amount. The adjustable range is $\pm 100\%$.

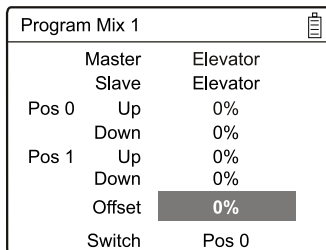

(1.4) Switch Selection

Press UP or DN to select "Switch". Press ENT to enter Switch interface, press UP or DN to choose desired item. Press ENT to confirm, the desired item whose left side will be changed into "1" from "0". If two or more items are selected, the item And should be selected, whose left side should be changed into "1" from "0". Press EXT after finished it.

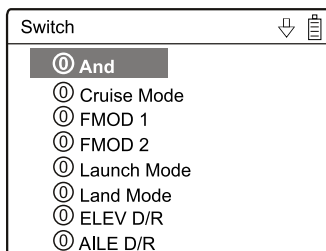
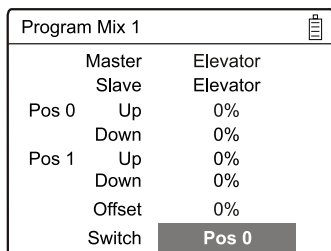

(2) Setting Method for Curve in Program Mix1

In the Program Mix interface, press UP or DN to select Curve, press ENT to confirm. Then the interface pop up "All Servos Hold?", press R or L to choose OK or Cancel. If select OK, all the servos will be locked in the current status, if select Cancel, all servos are unlocked. Press ENT to setting interface of program Mix1 and it will show the setting item.

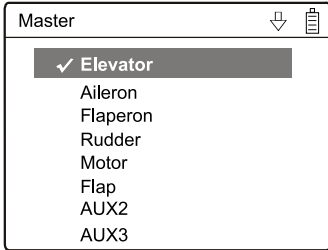
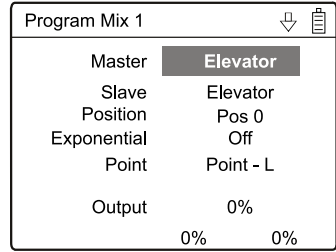
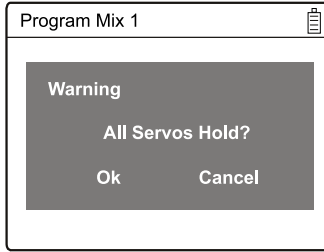

(2.1) Master channel setting

Press UP or DN to move the navigational mark to select Master option and press ENT to Master interface. Press UP or DN to select the desired channel and press ENT to make a "✓". Press EXT to be back to Program Mix 1 interface.

(2.2) Slave channel setting

Press UP or DN to move the navigational mark to select Slave option and press ENT to Slave interface. Press UP or DN to select the desired channel and press ENT to make a "✓". Press EXT to be back to Program Mix1 interface.

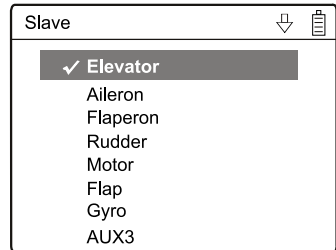

(2.3) Position

There have two options:Pos 0 and Pos 1. Press UP or DN to move the navigational mark to select the "position", press R or L to select "Pos 0" or "Pos 1" .

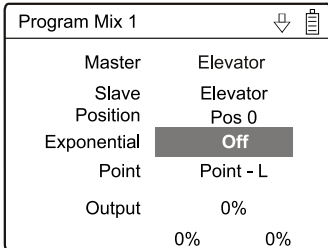

(2.4) Exponential Curve

Press UP or DN to choose the setting item of "Exponential" .There are On or Off option when you press the R or L buttons. Select On for smooth changes, and Off for changes in the form of fold ling in Exponential curve, respectively.

(2.5) Point Setting

Press UP or DN to move the navigation mark of Point option. Press R or L, there are 7 piont options including "Point-L", "Point-1", "Point-2", "Point-M", "Point-3", "Point -4" and "Point-H". Select the point you want to set.

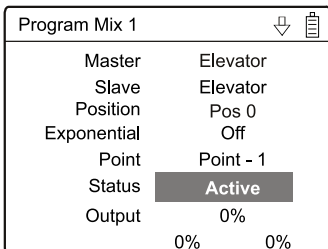
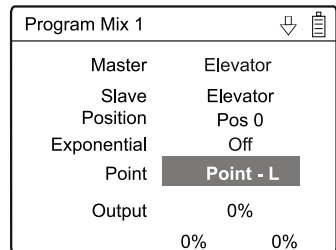

(2.6) Status setting

(There is no Status options when the piont is Point-L or Point-H) After selecting the point that you want to set, press UP or DN to move the navigational mark to Status item. Press R or L, there are two options of Inhibit and Active. Select Inhibit for unchanging the current amount (the default setting is Inhibit).

(2.7) output setting

When the Status option is Active, the Output option will be listed. Press UP or DN to move the navigational mark to Output. Press R or L to increase or decrease, respectively, the output amount. It is possible to reverse the mix direction by changing the plus or minus sign before the amount. The adjustable range is $\pm 100\%$.

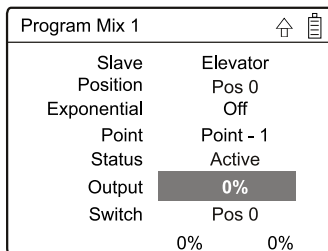

(2.8) Switch Selection

Press UP or DN to select "Switch". Press ENT to enter Switch interface, press UP or DN to choose desired item. Press ENT to confirm, the desired item whose left side will be changed into "1" from "0". If two or more items are selected, the item And should be selected, whose left side should be changed into "1" from "0". Press EXT after finished it.

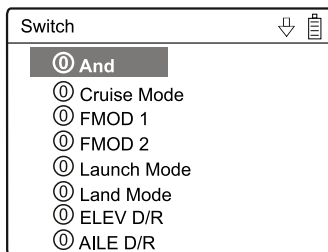
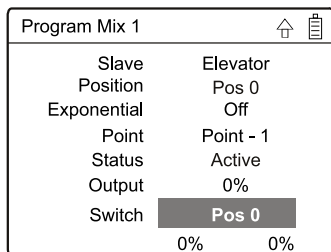

3.19 Monitor

This function can display the current status and positions of all the channels' outputs, and check the current working status of each channel.

Press ENT to enter Main Menu, and then press UP or DN to move the navigational mark to select Function Menu. Press ENT to enter the Function Menu and then press UP or DN to select servo Monitor and press ENT to enter the monitor interface for checking the current working status of each channel. Press EXT to exit .

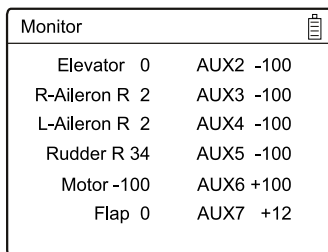

3.20 Fail safe

There are two possibilities for use if the transmission signal is under abnormal condition. The first one is to lock the last action data received; the second one is to execute the pre-set data which is pre-set. The default setting is Servo Hold.

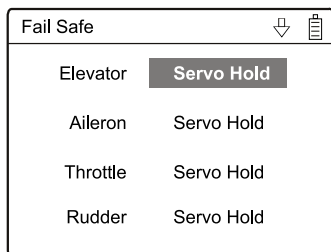

Setting method:

Press ENT to enter the Main Menu, and then press UP or DN to move the navigational mark to select Function Menu. Press ENT to enter the Function Menu then press UP or DN to select Fail Safe and press ENT to enter the Fail Safe interface. Take the item Elevator as an example to explain.

Press UP or DN to select Elevator on the Fail Safe interface, then press R or L to change the status of Servo Hold into Fail Safe (If you want to keep Servo hold status, there is no need to re-set). There is an expanded sub-item below. Press UP or DN to select 0%, then press R or L to increase or decrease, respectively, the position amount which centers on the neutral point of servo. The available value is 125%, respectively. 0% is the neutral point of servo.

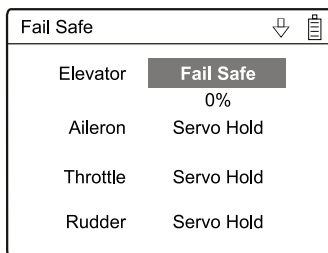

The setting methods for other channels are same as above.

Press EXT to exit after finished.

Note: checking whether all the actions when fail safe happened are correct, is a must after the setting is finished. It is dangerous to use full throttle, especially after fail safe taken place.

3.21 Sensor View

Setting method: Press ENT to enter the Main Menu and press UP or DN to move the navigational mark to

select Function Menu. Then press ENT to enter the Function Menu and press UP or DN to select Sensor View, then press ENT to enter the Sensor View interface, like below pictures. If all the sensors disconnect, telemetry signal lost, there will be inhibits shown on the view. If all work normal, all the measured data will be shown.

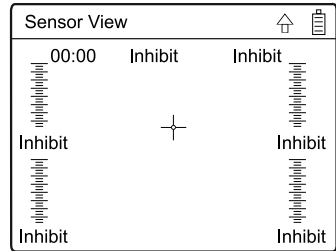
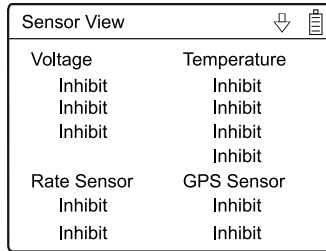

(1) Voltage: Show 3 different measured voltage value;

(2) Temperature: Show 4 different measured temperature value;

(3) Rate Sensor: Show 2 different measured RPM value;

(4) GPS image display: in the interface of Sensor View, press DN to go to GPS image display. It will show: local Timer, longitude, latitude, altitude, move speed, horizontal distance and battery Volume. If you set the image as the background, these informations will be seen from the image.

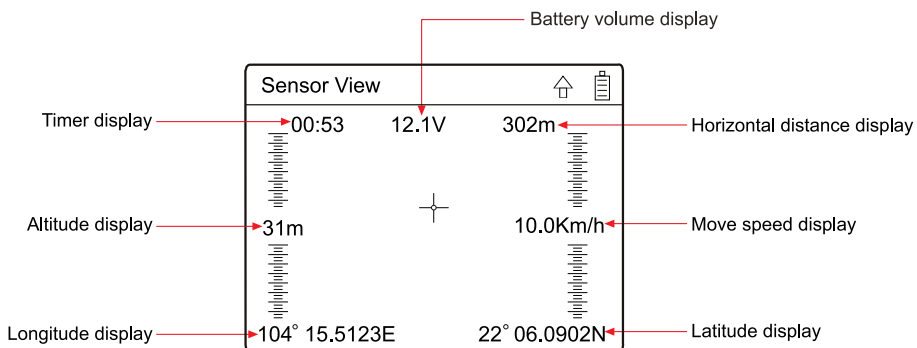
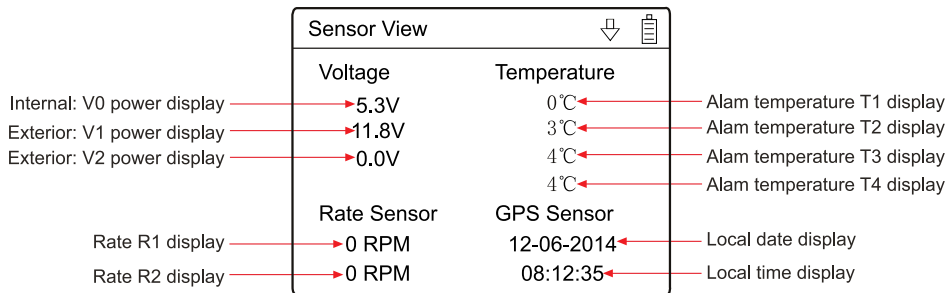

3.22 Trainer

Two DEVO F12E transmitters working together can execute the training function to meet the requirements for the beginner. The setting method is shown as below:

(1) Data copy

First, use the wireless copy function between two DEVO F12E to copy the main transmitter's model data to the trainee's transmitter, this promise the model data between two transmitters is same. Refer the copy method to the second part of helicopter "2.4 model wireless copy" and do the following steps:

(2) Linkage

Insert the digital signal wire from the trainer's transmitter into the DSC socket of the trainee's transmitter. Turn on the transmitter and a linkage icon will be shown on the boot screen.

linkage icon

Turn on the power of the trainer's radio. Find out the trainee's model data, and then let the trainer's Radio bind with the aircraft model and fly it normally. Then turn off the power. Insert the other end of the digital signal wire into the trainer's DEVO F12E, and then turn on its power. A linkage icon will be shown as below:

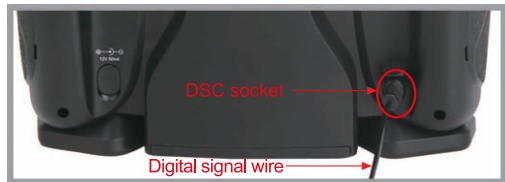
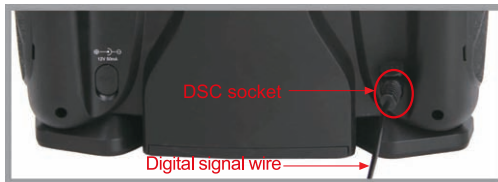
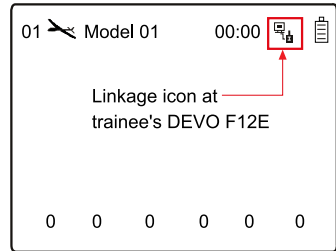

Trainer icon

Training status display: when the trainer's icon becomes into "X", the trainee stops flying and the trainer is working; when the trainer's icon turns into "✓", the trainee is flying and the trainer is in leisure.

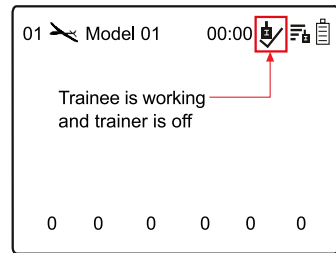
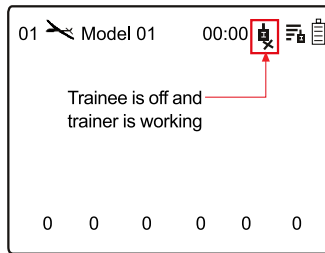

(3) Usage method

The training switch can be freely switchable between left trim and right trim. The default setting is right trim, see as the right illustration.

During flight, if the trainer pushes Right Trim once, the linkage icon will be shown as "✓" that means the control right is moved to the trainee from Trainer. If trainer pushes Right Trim once again, the linkage icon will be shown as "X" that means the trainer takes back the control right from the trainee.

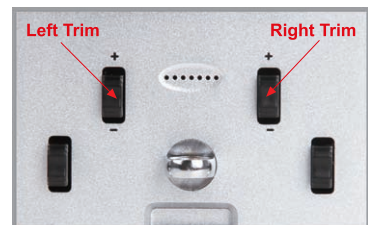

(4) Setting for training function channels

Trainee is available to get full or part of flight control power to the aircraft model via setting the training function channel in the trainer's radio. Below is the setting method:

Trainer	
Switch	Right Trim
Elevator	Inhibit
R-Aileron	Inhibit
L-Aileron	Inhibit
Rudder	Inhibit
Motor	Inhibit
Flap	Inhibit
AUX2	Inhibit

Press the ENT to enter Main Menu, and then press UP or DN to move the navigational mark to select Function Menu. Then press ENT to enter the Function Menu and press UP or DN to select "Trainer", then press ENT to enter the Trainer interface. The available channels are shown as left illustration, and the current status of trainer switch is also shown there.

Welcome to use the DEVO F12E transmitter

Trainer switch selection: Press UP or DN to select the switch option; press R or L to select the switch which you want. It includes right and left trim. The default setting is Right trim.

Channel selection: Press UP or DN to select the channel option; Press R or L to select the channel(s) which you want to grant to trainee. The channel(s) you have selected will be activated as "Active". The channels which are not granted to trainee will be kept inhibited. The default setting is "Inhibit".

Press EXT to exit.

3.23 Timer

There are two timers which can be set as stopwatch and countdown, respectively. Each timer can be operated by switch or by shortcut.

Setting method:

Press ENT to enter Main Menu, and then press UP or DN to move the navigational mark to select Function Menu. Then press ENT to enter the Function Menu and press UP or DN to select "Timer", then press ENT to enter Timer interface. The timing range of stopwatch is from 00:00 to 59:59 (59 minutes 59 seconds). The default setting is stopwatch.

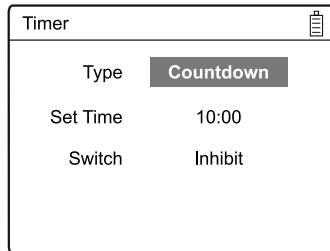
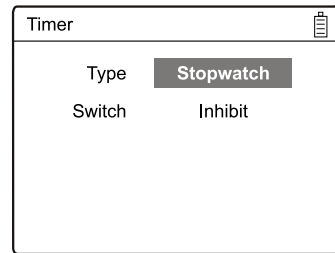

(1) Countdown setting

If you need countdown time manner, press R or L to select the countdown. There is an expand sub-menu set time item. Press UP or DN to move the navigational mark to select the option of Setting time item. Press R or L to set the countdown time. The settable countdown time range is from 00:10 to 59:50.

(2) Switch selection

Press UP or DN to move the navigational mark to Switch. There are Inhibit and available switch options, available switch can be selected by press L or R. It includes FMOD1,2, FMOD2, MIX1,2, MIX2, ELEV D/R, AILE D/R, RUDD D/R, GEAR SW, SPS0 SW, SPS1 SW, SPS2 SW and SPS3 SW. We can select the desired item except these items of SPS0 SW, SPS1 SW, SPS2, and SPS3 which should be previously set at Stick Position Switch at Model Menu (refer to "2.8 Stick Position Switch").

Press EXT to exit after finished.

(3) Usage of timer

Press UP or DN in main panel. It's possible to start Timers by pressing UP key for one time, and to pause it by pressing it the second time. Press DN to clear timer. It's ok to control time by Switch when time setting is finished on switch. Timer will be shown in main interface, as right illustration:

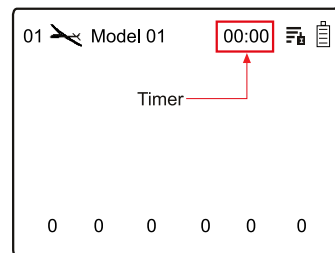

4.0 Upgrading

Software can be upgraded in PC via downloading or uploading the configuration files.

Enter upgrading interface: Press EXT and power on the radio when the radio is in powered off status, the illustration will be shown in the right.

The operation guide for connecting to PC upgrading should be mentioned with upgrading software.

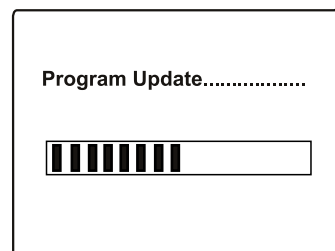

FCC Information

This device complies with part 15 of the FCC results. Operations is subject to the following two conditions:

- (1) This Device may not cause harmful interface, and
- (2) This device must accept any interference received, including interference that may cause undesired operation.

Note: This equipment has been tested and found to comply with the limits for CLASS B digital device, pursuant to part 15 of FCC Rules. These Limits are designed to provide reasonable protection against harmful interference when the equipment is operated in a commercial environment. This equipment generates, users can radiate radio frequency energy and, if not installed and used in accordance with the instructions, may cause harmful interference to radio communications. However, there is no guarantee that interference will not occur in a particular installation. If this equipment does cause harmful interference to radio or television reception, which can be determined by turning the equipment off and on, the user is encouraged to try contact the interference by one or more of the following measures:

- 1.1 Reorient or relocate the receiving antenna.
- 1.2 Increase the separation between the equipment and receiver.
- 1.3 Connect the equipment into an outlet on a circuit different from that two which receiver is connected.
- 1.4 Consult the dealer or experienced radio/TV technician for help.

WARNING

Changes or modifications not expressly approved by the manufacturer could void the user's authority to operate the equipment.

RF exposure statement

This module meets the requirements for a mobile device that may be used at separation distances of more than 20cm from the human body. It may be used in hand-held controllers that provide a separation distance of at least 5cm between the antenna and the body (excluding hands wrists). The instructions to the user for the host device must include information requiring the product be used in a manner to ensure the appropriate separation (20cm or 5cm) between antenna and body and requiring that the transmitter not be collocated with another transmitter device.



This symbol indicating separate collection for electrical and electronic equipment.

deVention

Add.: Taishi Industrial Park, Dongchong Town
Panyu District, 511475 Guangzhou

Tel.: (8620) 8491 5115 8491 5116

Fax.: (8620) 8491 5117

Web: www.walkera.com

Email: heli@walkera.com
info@walkera.com

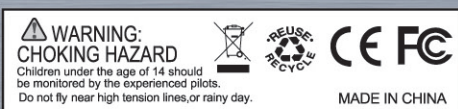

The specifications of the R/C aircraft may
be altered without notice.