

FIREFLY

SONY 12 Mega pixels HD DV

■ WiFi

■ SONY 12M COMS

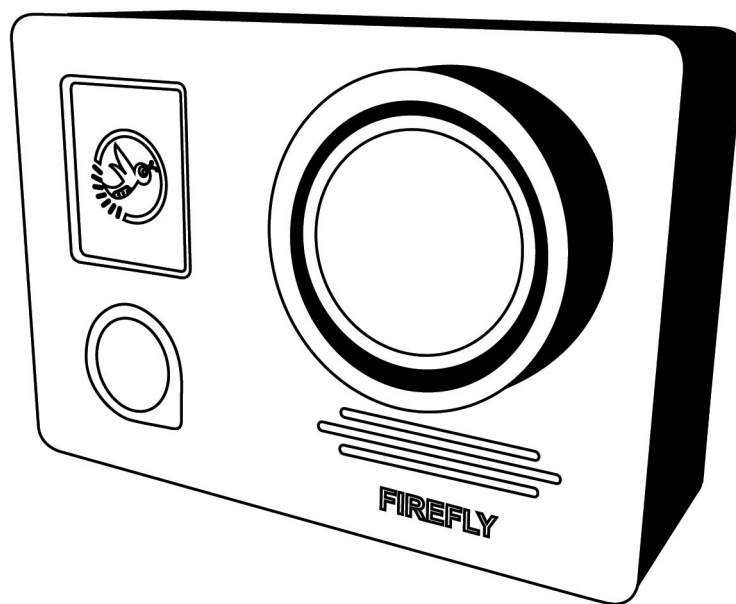

Ver 2.5

Contents

- Features : 3
- OLED Status Screen.....4
- Button Functions.....6
- Menu Description:..... 6
- Wi-Fi Remote:..... 8
- Time update:.....9
- Battery Charging:.....9
- Transferring Files:.....9

Features :

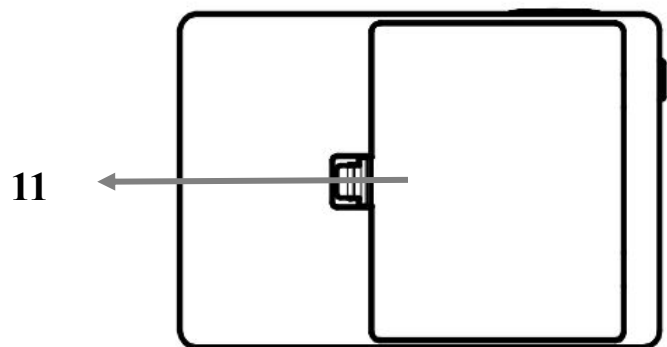
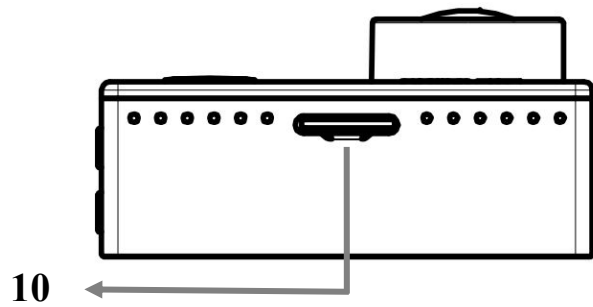
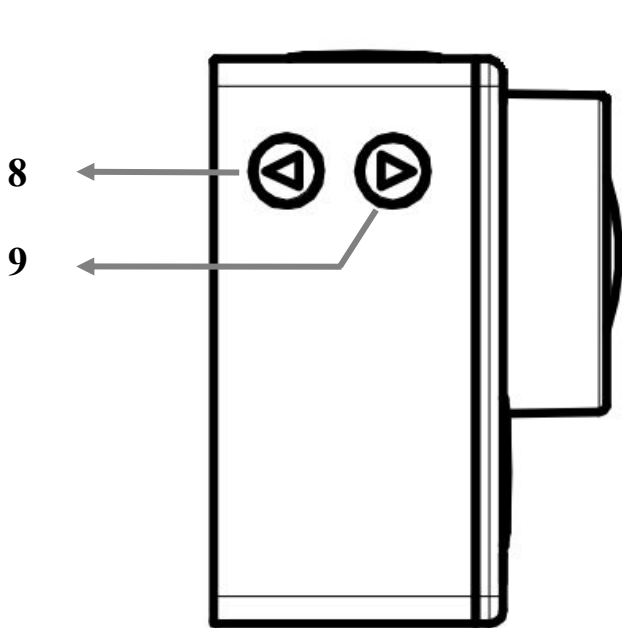
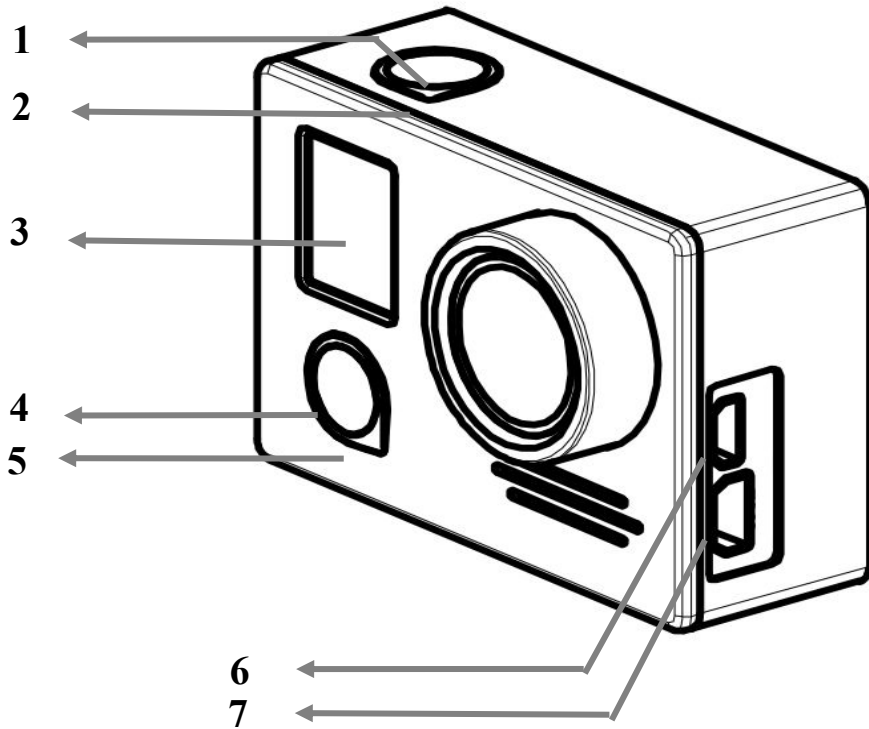

- 1.OK Button
- 2.Camera Status LED
- 3.OLED Status Screen
- 4.Power/Mode Button
- 5. Working/Charging Status Light
- 6. HDMI Port

- 7. USB/AV Port
- 8. Down Button
- 9. Up Button/ shortcut to WIFI
- 10. TF Card Slot
- 11. Battery Door

OLED Status Screen

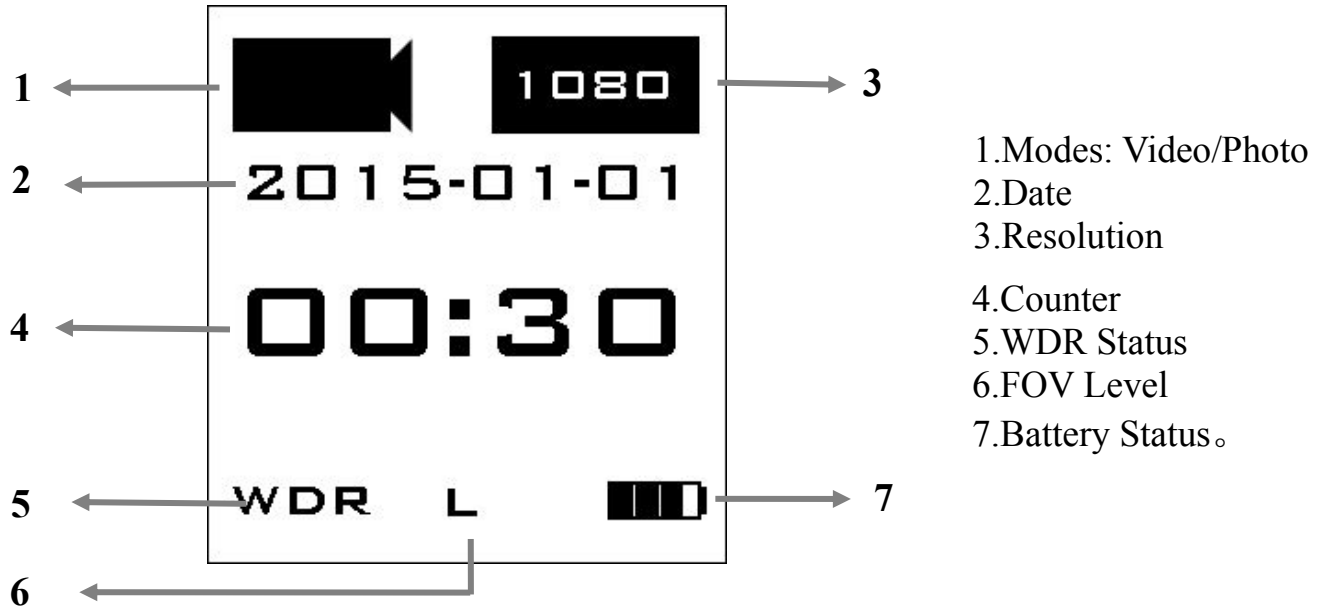

Note: Please use a C10 TF Card (when the card speed is not match,it will show “ card speed low ”) , free up its data and format it in FAT32 before use.

Performance and Specifications:

	Photo resolution	12M
	AV output format USB Port	PAL/NTSC (fit for gopro gimbals)
	HDMI Output	YES
	Kind of TF card supported	Class 10
	Maximum size of TF card supported	64G
	Wi-Fi	YES
Specifications	Camera size	59×41×21 MM
	Weight	70g
	Battery Capacity (Battery is removable, exchangeable with battery of gopro3/3+)	1600mAH
	Battery life	2 hours
	Time to complete charging	2-3 hours
	Compressed format	H264
	Video/photo format	*.MOV / *.JPG
Optical Parameter	Diaphragm	F/2.8 , 7 glasses
	Angle	Horizontal 105 degree Diagonal 140 degree
Electric Parameter	Working Voltage	5V
	current	800mA
Working Modes	Video	
	Photo	
	Time-lapse video	
	Time-lapse photo	
	11 Burst Photo	

Button Functions

Name	Functions	Descriptions
Power/Mode Button	Turn on/off camera; select modes	Press once, camera on; press for 3 seconds, camera off/ press to select photo or video mode.
OK Button	start/stop recording	
UP Button	move upwards	Enter menu setting/move upwards/Press for 3 sec, WIFI ON
DOWN Button	Move downwards	Enter menu setting/move downwards

Menu Description:

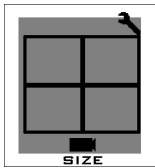

Video resolution: select from 1080P@30fps and 720p@60fps,etc.

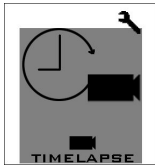

Time-lapse video: to start/stop time-lapse video at 0.5 or 3 second intervals.

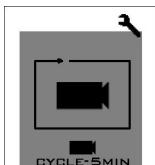

Cycle recording: If cycle recording mode is selected, the video will be cut into 5-minute segments. The earliest files will be covered when the TF card is full. (This mode is suggested to be used in vehicle monitoring.)

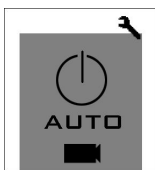

USB Power Up Auto-record: If this function on, it will automatically start recording when connected to external power source via USB. (This mode is suggested to be used in vehicle monitoring or aerial photographing.)

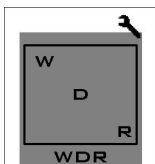

WDR (Wide Dynamic Range): WDR function is suggested to be used in cloudy/dark environment. It might cause overexposure in sunny days. (This mode is not suggested to be used in sunny days).

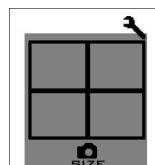
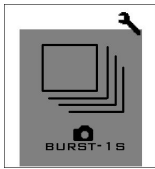
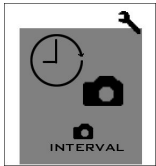

Photo resolution: 12M / 8M / 5M
(12M is suggested)



Burst photo: capture 11 photos in 1 second.



Continuous photo: This option allows you to capture photos continuously every 3 /10/30second. Note: Continuous photo mode has more priority than burst photo mode.

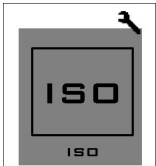

ISO adjustment: AUTO/100/400/1600.ISO of photos can be adjusted. At night, the lower ISO you select, the better image effect you get.
(Note: please hold your camera steady when taking photos)

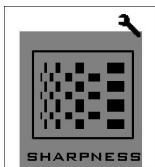

Sharpness adjustment: 3 options: High, Medium and Low. Low sharpness is suggested at night.
(Under recording mode, Medium level is suggested; under photographing mode, Medium level is suggested for close-shot or in dark environment and High level is suggested for long-shot.)

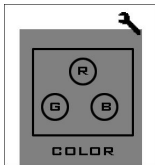

Color adjustment: 2 options: standard and vivid.
(If you want post-production, standard option is suggested.)

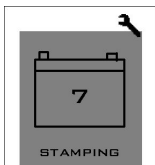

Time stamping: this option allows you to stamp the time on the photos or videos.

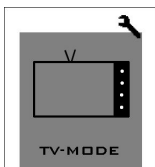

TV output mode: PAL / NTSC



Wi-Fi remote: the camera's built-in Wi-Fi allows you to connect to the smart phone/tablet via the Firefly App. You can view the photos and videos taken by the camera on your smart phone/tablet; you can also use your smart phone/tablet to control the camera to capture photos or record videos.

(Note: too long distance between WIFI and camera might cause image loss.)

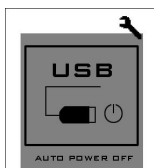

USB Auto power-off: the power will be automatically turned off in 30 seconds after the USB power supply is cut.

(This function is suggested to be used in aerial photographing.)

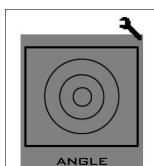

Angle adjustment: 3 options: Large / Medium / Small. Small angle can reduce image distortion.

(**Large** angle is suggested as using smaller angle will reduce image quality.)

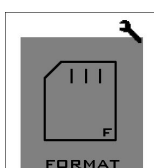

TF card formatting: After power on, if the format of TF card does not fit the system, you will see a tip “please format card” and please use this function then.

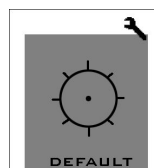

Factory default settings: you can use this function to resume all factory default settings.

(Note: if the camera does not work normally, please resume all factory default settings and then restart it again.)



System version: enter to see the system version of the camera.

Wi-Fi Remote:

You can use a Smart phone/tablet to view or take photos and videos via Wi-Fi connection.



1. Download and install FIREFLY app from the app store on your smart phone/tablet, or scan the QR code for

iOS:



Android:



2. Turn camera's Wi-Fi on.
3. In your smart phone's or tablet's Wi-Fi network settings, connect to the camera's Wi-Fi network named "FIREFLY_xxxx", enter the password. Default password is "12345678".
4. Open the FIREFLY app on your smart phone/tablet. You will now be able to control the camera with your smart phone/tablet plus view, playback and share selected content.

Time update:

When connected to the Wi-Fi, time will be updated automatically.

Battery Charging:

Connect the camera to a computer or phone charger using the included USB cable. Use 1A charger, and turn off the camera when charging will increase the charging rate. The Charging Status Light it will turn OFF when the battery is fully charged.

Transferring Files:

1. Connect the camera to a computer via the included USB cable, and then turn on the camera.
2. Double click "My Computer" and locate "Removable Disk". Enter "Removable Disk" and you will find all photo and video files in DV folder.