

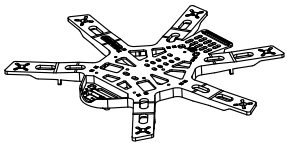

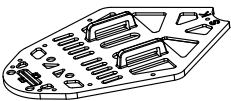

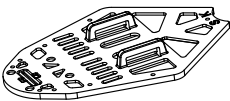

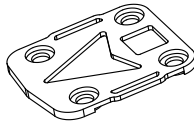
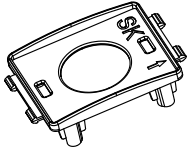

KINGKONG HEX300 INSTRUCTION MANUAL

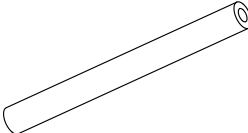
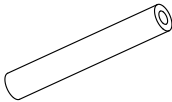
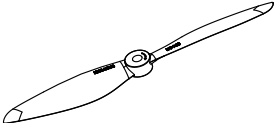
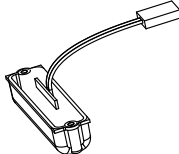
PARTS LIST

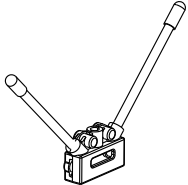
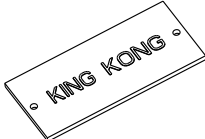
			
FRAME BLACK X1	TOP PLATE BLACK X1	TOP PLATE GREEN X1	
			
PART GREEN X1	PART GREEN X1	RUBBER BALL X4	
			
$\Phi 4 \times 37$ X2	$\Phi 4 \times 27$ X5	5040 X10PAIRS	
			
LED PCB X2	STRAP X1	X1	
			
POWER HUB PCB X1	M2.5*6 X14	ST2*8 X8	1806 MOTOR SCREWS M2*6.7 X24

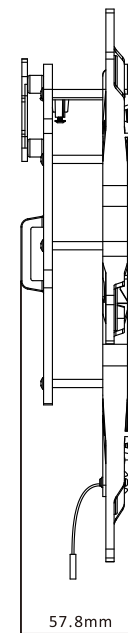
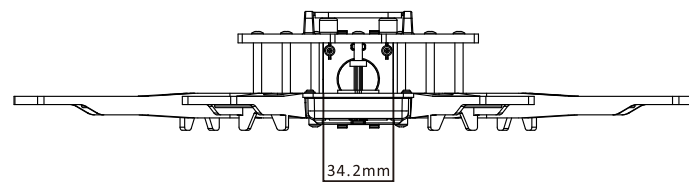
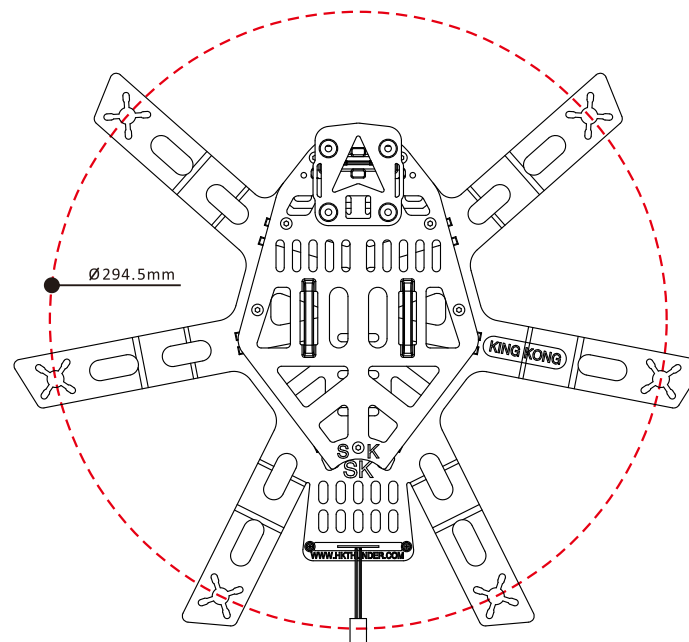

The color of LED is random.

RED GREEN WHITE YELLOW